

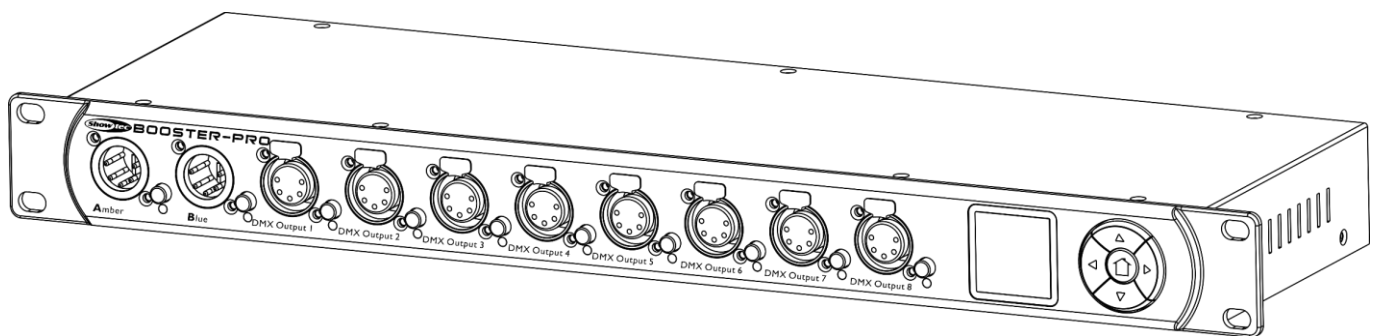

# USER MANUAL



ENGLISH

## Booster Pro

V3

Product code: 50789  
Firmware: 1.8

## Preface

---

Thank you for purchasing this Showtec product.

The purpose of this user manual is to provide instructions for the correct and safe use of this product.

Keep the user manual for future reference as it is an integral part of the product. The user manual shall be stored at an easily accessible location.

This user manual contains information concerning:

- Safety instructions
- Intended and non-intended use of the device
- Installation and operation of the device
- Maintenance procedures
- Troubleshooting
- Transport, storage and disposal of the device

Non-observance of the instructions in this user manual may result in serious injuries and damage of property.

©2020 Showtec. All rights reserved.

No part of this document may be copied, published or otherwise reproduced without the prior written consent of Highlite International.

Design and product specifications are subject to change without prior notice.

For the latest version of this document, please visit our website [www.highlite.com](http://www.highlite.com) or contact us at [service@highlite.com](mailto:service@highlite.com).

Highlite International and its authorized service providers are not liable for any injury, damage, direct or indirect loss, consequential or economic loss or any other loss arising from the use of, or inability to use or reliance on the information contained in this document.

## Table of contents

<b>1. Introduction.....</b>	<b>4</b>
1.1. Before Using the Product .....	4
1.2. Intended Use .....	4
1.3. Text Conventions .....	4
1.4. Symbols and Signal Words.....	5
1.5. Symbols on the Information Label .....	5
<b>2. Safety .....</b>	<b>5</b>
2.1. Warnings and Safety Instructions .....	6
2.2. Requirements for the User.....	7
<b>3. Description of the Device .....</b>	<b>8</b>
3.1. Front View .....	8
3.2. Back View .....	8
3.3. Product Specifications .....	9
3.4. Dimensions.....	9
<b>4. Installation .....</b>	<b>10</b>
4.1. Safety Instructions for Installation .....	10
4.2. Installation Site Requirements .....	10
4.3. Rack Mounting .....	10
4.4. Connecting to Power Supply .....	10
<b>5. Setup .....</b>	<b>11</b>
5.1. Warnings and Precautions .....	11
5.2. DMX Connection.....	11
5.2.1. DMX-512 Protocol .....	11
5.2.2. DMX Cables.....	11
5.3. Setup Examples .....	12
<b>6. Operation .....</b>	<b>13</b>
6.1. Safety Instructions for Operation .....	13
6.2. Start-up.....	13
6.3. Control Panel .....	13
6.4. Input Ports Monitoring.....	14
6.4.1. Home Screen.....	14
6.4.2. Quick Access.....	14
6.4.3. Access via the Main Menu .....	15
6.5. Output Ports Configuration .....	15
6.5.1. Quick Access.....	15
6.5.2. Access via the Main Menu .....	16
6.6. Merge Function .....	16
6.6.1. HTP (Highest Takes Precedence).....	16
6.6.2. LTP (Latest Takes Precedence) .....	16
6.6.3. A + B .....	16
6.6.4. Backup.....	16
6.7. LED Statuses.....	17
6.8. Menu Overview .....	18
6.9. Main Menu Options .....	20
6.9.1. Input A .....	20
6.9.1.1. Mode .....	20
6.9.1.2. Failure Behavior .....	21
6.9.1.3. Status Information .....	21
6.9.2. Input B.....	22
6.9.2.1. Mode .....	22
6.9.2.2. Failure Behavior .....	23
6.9.2.3. Status Information .....	23
6.9.3. Merge .....	24

- 6.9.3.1. Mode .....24
- 6.9.3.2. Failure Behavior .....25
- 6.9.4. Outputs .....25
- 6.9.5. DMX Error Alarm .....26
- 6.9.6. Settings.....26
  - 6.9.6.1. Label .....26
  - 6.9.6.2. Information .....27
- 6.9.7. Set Default .....27
- 7. Troubleshooting .....28**
- 8. Maintenance .....28**
  - 8.1. Safety Instructions for Maintenance .....28
  - 8.2. Preventive Maintenance .....28
    - 8.2.1. Basic Cleaning Instructions .....29
  - 8.3. Corrective Maintenance .....29
    - 8.3.1. Replacing the Fuse.....29
- 9. Deinstallation, Transportation and Storage .....30**
- 10. Disposal .....30**
- 11. Approval.....30**

## 1. Introduction

### 1.1. Before Using the Product



**Important**  
Read and follow the instructions in this user manual before installing, operating or servicing this product.

The manufacturer will not accept liability for any resulting damages caused by the non-observance of this manual.

After unpacking, check the contents of the box. If any parts are missing or damaged, contact your Highlite International dealer.

Your shipment includes:

- Showtec Booster Pro
- Schuko to pro-power cable (1,5 m)
- User manual

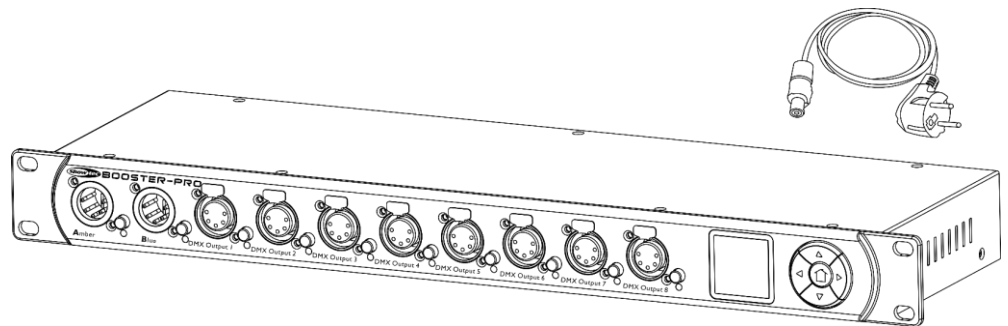

Fig. 01

### 1.2. Intended Use

This device is intended for use as a DMX splitter/booster. It is suitable only for indoor installation. It is not suitable for households.

Any other use, not mentioned under intended use, is regarded as non-intended and incorrect use.

### 1.3. Text Conventions

Throughout the user manual the following text conventions are used:

- Buttons: All buttons are in bold lettering, for example "Press the **UP/DOWN** buttons"
- References: References to chapters and parts of the device are in bold lettering, for example: "Refer to **2. Safety**", "press the **power switch (03)**"
- 0–255: Defines a range of values
- Notes: **Note:** (in bold lettering) is followed by useful information or tips

## 1.4. Symbols and Signal Words

Safety notes and warnings are indicated throughout the user manual by safety signs.

Always follow the instructions provided in this user manual.

**DANGER**

Indicates an imminently hazardous situation which, if not avoided, will result in death or serious injury.

**WARNING**

Indicates an imminently hazardous situation which, if not avoided, could result in death or serious injury.

**CAUTION**

Indicates a potentially hazardous situation, which, if not avoided, may result in minor or moderate injury.

**Attention**

Indicates important information for the correct operation and use of the product.

**Important**

Read and observe the instructions in this document.

**Electrical hazard**

Provides important information about the disposal of this product.

## 1.5. Symbols on the Information Label

This product is provided with an information label. The information label is located on the bottom plate of the device.

The information label contains the following symbols:



This device is designed for indoor use.



This device shall not be treated as household waste.



Caution: Risk of electric shock. Disconnect input power before opening.  
Warning: This appliance must be earthed.

## 2. Safety

**Important**

**Read and follow the instructions in this user manual before installing, operating or servicing this product.**

The manufacturer will not accept liability for any resulting damages caused by the non-observance of this manual.

## 2.1. Warnings and Safety Instructions



**DANGER**  
**Danger for children**

For adult use only. The device must be installed beyond the reach of children.

- Do not leave various parts of the packaging (plastic bags, polystyrene foam, nails, etc.) within children's reach. Packaging material is a potential source of danger for children.



**DANGER**  
**Electric shock caused by short-circuit**

This device falls under IEC protection class I.

- Make sure that the device is electrically connected to ground (earth). Connect the device only to a socket-outlet with ground (earth) connection.
- Do not cover the ground (earth) connection.
- Do not bypass the thermostatic switch or fuses.
- For replacement use fuses of the same type and rating only.
- Do not let the power cable come into contact with other cables. Handle the power cable and all connections with the mains with caution.
- Do not modify, bend, mechanically strain, put pressure on, pull or heat up the power cable.
- Make sure that the power cable is not crimped or damaged. Examine the power cable periodically for any defects.
- Do not immerse the device in water or other liquids. Do not install the device in a location where flooding may occur.
- Do not use the device during thunderstorms. Disconnect the device from the electrical power supply immediately.



**WARNING**  
**Electric shock caused by dangerous voltage inside**

There are areas within the device where dangerous touch voltage may be present.

- Do not open the device or remove any covers.
- Do not operate the device if the covers are open.
- Disconnect the device from electrical power supply before service and maintenance, and when the device is not in use.



**Attention**  
**Power supply**

- Before connecting the device to the power supply, make sure that the current, voltage and frequency match the input voltage, current and frequency specified on the information label on the device.
- Make sure that the cross-sectional area of the extension cords and power cables is sufficient for the required power consumption of the device.



### **Attention** **General safety**

- Do not block the ventilation openings. Without proper heat dissipation and air circulation, the internal components may overheat. This can result in product damage.
- Do not shake the device. Avoid brute force when installing or operating the device.
- If the device is dropped or struck, disconnect the device from the electrical power supply immediately.
- If the device is exposed to extreme temperature variations (e.g. after transportation), do not switch it on immediately. Let the device reach room temperature before switching it on, otherwise it may be damaged by the formed condensation.
- If the device fails to work properly, discontinue the use immediately.



### **Attention** **This device shall be used only for the purposes it is designed for.**

This device is designed to be used as a DMX splitter/booster. Any incorrect use may lead to hazardous situations and result in injuries and material damage.

This device does not contain user-serviceable parts. Unauthorized modifications to the device will render the warranty void. Such modifications may result in injuries and material damage.



### **Attention** **Do not expose the device to conditions that exceed the rated IP class conditions.**

This device is IP20 rated. IP (Ingress Protection) 20 class provides protection against solid objects greater than 12 mm, such as fingers, and no protection against harmful ingress of water.

## **2.2. Requirements for the User**

This product may be used by ordinary persons. Maintenance and installation may be carried by ordinary persons. Service shall be carried out only by instructed or skilled persons. Contact your Highlite International dealer for more information.

Instructed persons have been instructed and trained by a skilled person, or are supervised by a skilled person, for specific tasks and work activities associated with the service of this product, so that they can identify risks and take precautions to avoid them.

Skilled persons have training or experience, which enables them to recognize risks and to avoid hazards associated with the service of this product.

Ordinary persons are all persons other than instructed persons and skilled persons. Ordinary persons include not only users of the product but also any other persons that may have access to the device or who may be in the vicinity of the device.



### 3. Description of the Device

The Showtec Booster Pro is an optically isolated DMX splitter and booster. It is equipped with 2 inputs which can be patched to 8 selectable outputs. The device supports RDM and merging. It also offers real-time DMX monitoring of the input and output ports. In case of an error, an acoustic signal will warn the user.

#### 3.1. Front View

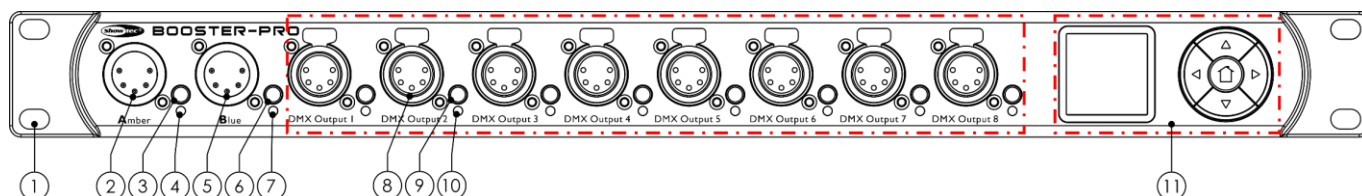
**Fig. 02**

- 01) 4 x mounting openings (for installation in a 19-inch rack)
- 02) 5-pin DMX connector IN (Input A, Amber)
- 03) Input port button (Input A)
- 04) LED indicator (Input A)
- 05) 5-pin DMX connector IN (Input B, Blue)
- 06) Input port button (Input B)
- 07) LED indicator (Input B)
- 08) 8 x 5-pin DMX connectors OUT (Outputs 1–8)
- 09) 8 x output port buttons (Outputs 1–8)
- 10) 8 x LED indicators (Outputs 1–8)
- 11) Control panel: OLED display and control buttons

#### 3.2. Back View

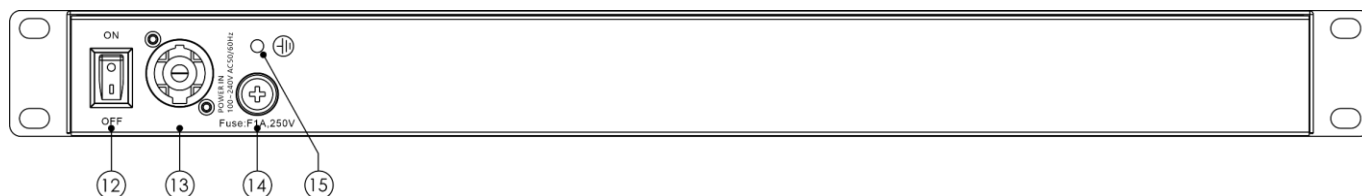
**Fig. 03**

- 12) Power switch
- 13) Pro-power connector IN
- 14) Fuse F1 A, 250 V
- 15) Ground (earth) connection

## 3.3. Product Specifications

Model:	Booster Pro
<b>Electrical:</b>	
Input voltage:	100–240 V AC, 50/60 Hz
Power consumption:	5 W
Fuse:	F1 A, 250 V
<b>Physical:</b>	
Dimensions:	482 x 137 x 44 mm (L x W x H)
Weight:	2 kg
<b>Operation and control:</b>	
Control protocols:	DMX-512, RDM
Control panel:	OLED display and buttons
<b>Connections:</b>	
Power connections:	Pro-power connector IN
Input connections:	2 x 5-pin DMX connectors IN
Output connections:	8 x 5-pin DMX connectors OUT (optically isolated)
<b>Construction:</b>	
Housing:	Metal and flame-retardant plastic
Color:	Black
IP rating:	IP20
Cooling:	Natural heat dissipation
<b>Thermal:</b>	
Maximum ambient temperature $t_a$ :	55 °C

## 3.4. Dimensions

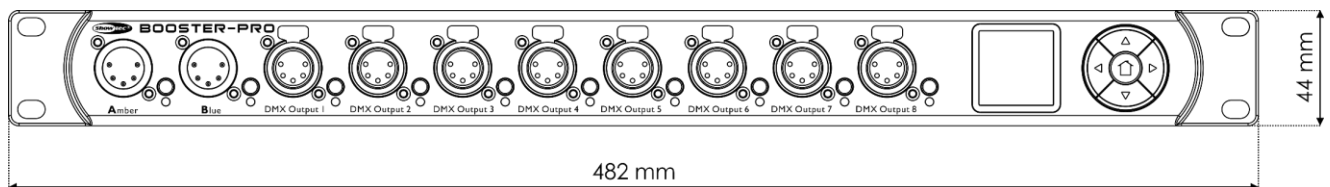

Fig. 04

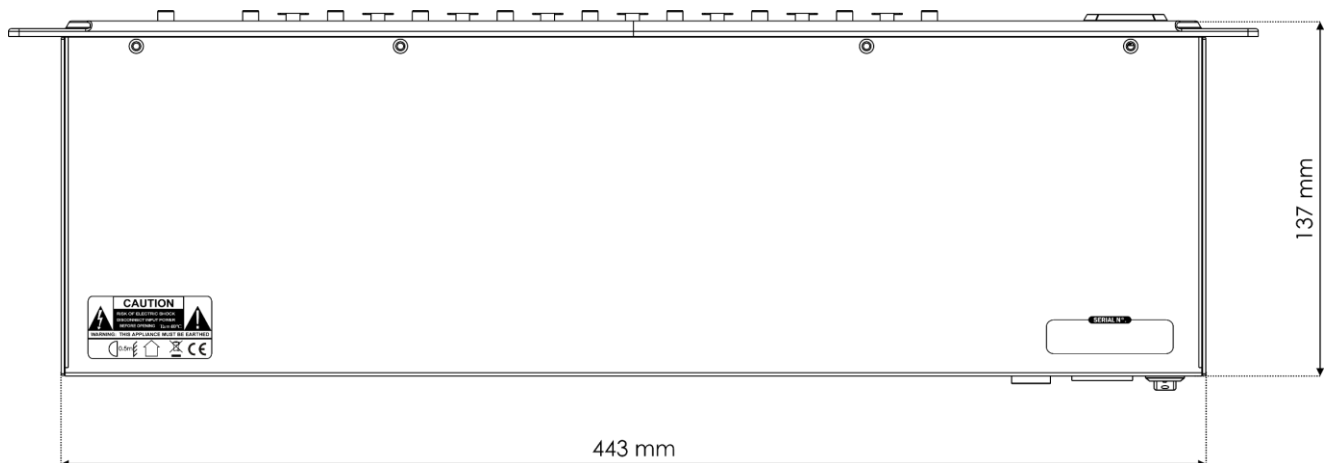

Fig. 05

## 4. Installation

### 4.1. Safety Instructions for Installation

**Attention**

**Make sure there is enough space for ventilation around the device.**

- Do not block the ventilation openings. Without proper heat dissipation and air circulation, the internal components may overheat. This can result in product damage.
- Do not install near equipment that produces heat, for example amplifiers.

### 4.2. Installation Site Requirements

- The device must be installed only indoors.
- The device can be placed on a flat surface or mounted in a standard 19-inch rack.
- The maximum ambient temperature  $t_a = 55\text{ °C}$  must never be exceeded.
- The relative humidity must not exceed 50 % with an ambient temperature of 50 °C.

### 4.3. Rack Mounting

The device can be mounted in a standard 19-inch rack. The device requires 1 rack unit (RU) of space, which is 44,45 mm high.

Make sure that the rack is sufficiently secured to prevent it from becoming unstable or falling over.

To mount the device in a two-post rack, follow the steps below:

- 01) Insert 4 cage nuts in the openings on the rack posts where you want to mount the device.
- 02) Position the device in front of the rack posts so that the 4 **mounting openings (01)** on the flanges face the openings on the rack posts with cage nuts.
- 03) Using a screwdriver, mount the device to the rack posts with 4 screws.

### 4.4. Connecting to Power Supply

**DANGER**

**Electric shock caused by short-circuit**

The device accepts AC mains power at 100–240 V and 50/60 Hz. Do not supply power at any other voltage or frequency to the device.

This device falls under IEC protection class I. Make sure that the device is always electrically connected to the ground (earth).

Before connecting the device to the socket-outlet:

- Make sure that the power supply matches the input voltage specified on the information label on the device.
- Make sure that the socket-outlet has ground (earth) connection.

Connect the device to the socket-outlet with the power plug.

## 5. Setup

### 5.1. Warnings and Precautions



**Attention**

**Connect all data cables before supplying power.**

**Disconnect power supply before connecting or disconnecting data cables.**

### 5.2. DMX Connection

#### 5.2.1. DMX-512 Protocol

DMX-512 is a communication protocol used to control stage lighting and effects.

Devices on a serial data link must be daisy-chained in a single line. To comply with the TIA-485 standard, no more than 32 devices should be connected on one data link.

In order to connect more than 32 devices on one data link, you can use a DMX optically isolated splitter/booster, such as the Booster Pro. If no splitter/booster is used, this may result in deterioration of the DMX signal.

#### 5.2.2. DMX Cables

Shielded twisted-pair cables with 5-pin XLR connectors must be used for reliable DMX connection. You can purchase DMX cables directly from your Highlite International dealer or make your own cables.

If you use XLR audio cables for DMX data transmission, this may lead to signal degradation and unreliable operation of the DMX network.

When you make your own DMX cables, make sure that you connect the pins and wires correctly as shown in Fig. 06.

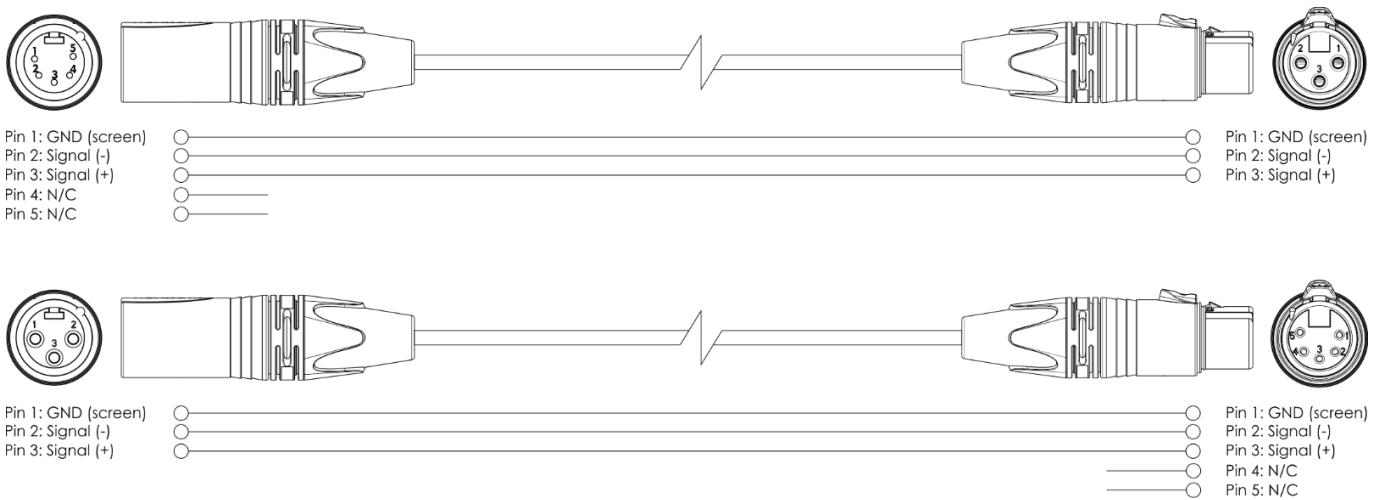

**Fig. 06**

### 5.3. Setup Examples

A typical setup with the device used as a splitter/booster:

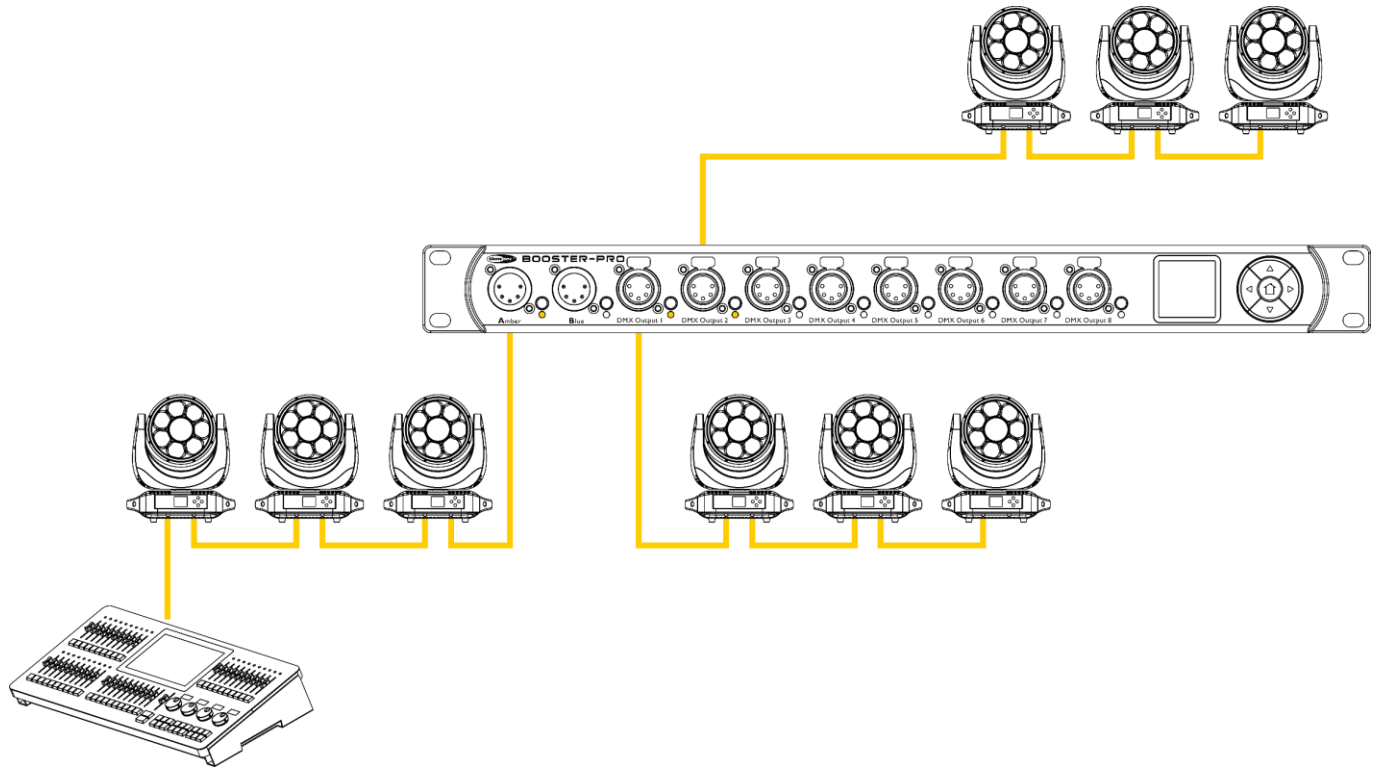

Fig. 07

A typical setup with 2 controllers:

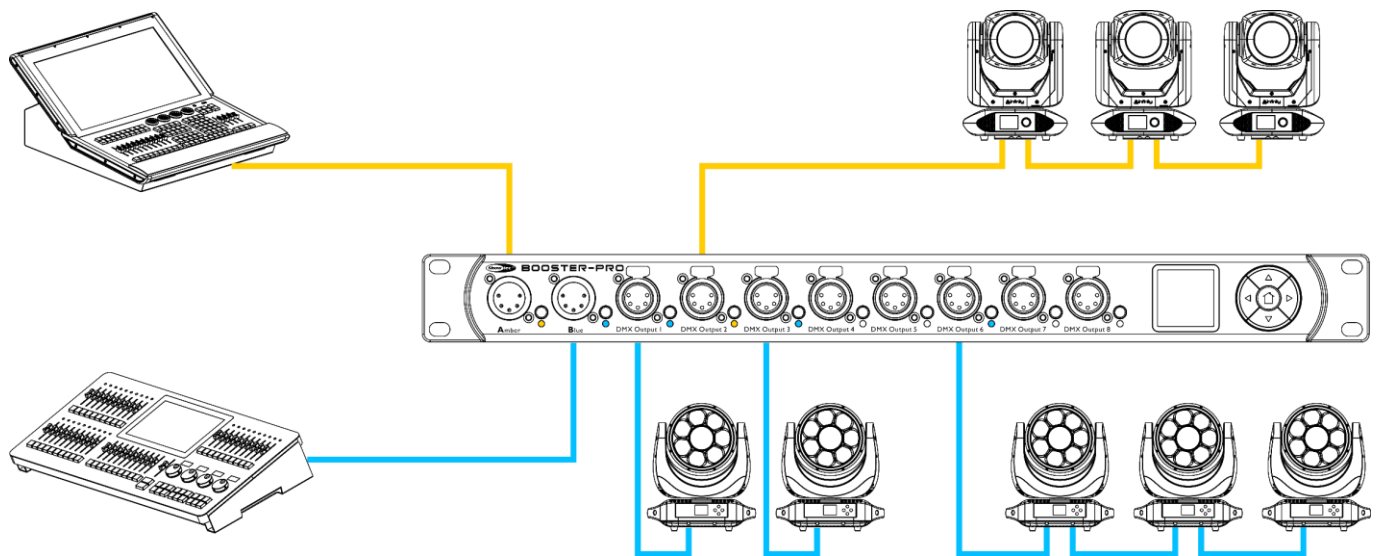

Fig. 08

## 6. Operation

### 6.1. Safety Instructions for Operation



**Attention**

This device must be used only for the purposes it is designed for.

This device is intended for use as a DMX splitter/booster. It is suitable only for indoor installation. It is not suitable for households.

Any other use, not mentioned under intended use, is regarded as non-intended and incorrect use.



**Attention**

**Power supply**

Before connecting the device to the power supply, make sure that the current, voltage and frequency match the input voltage, current and frequency specified on the information label on the device.

### 6.2. Start-up

The device has a power switch.

- Press the **power switch (12)** in ON position to turn the device on.
- Press the **power switch (12)** in OFF position to turn the device off.

At start-up the OLED display shows the home screen. The home screen provides side by side information about the connection status of Input A and Input B and the port mode. See **6.4.1. Home Screen** on page 14 for more information.

**Note:**

If no button is pressed, after 10 seconds of inactivity the display will return to the home screen and after 30 more seconds it will turn off. Press any button to turn the display on.

### 6.3. Control Panel

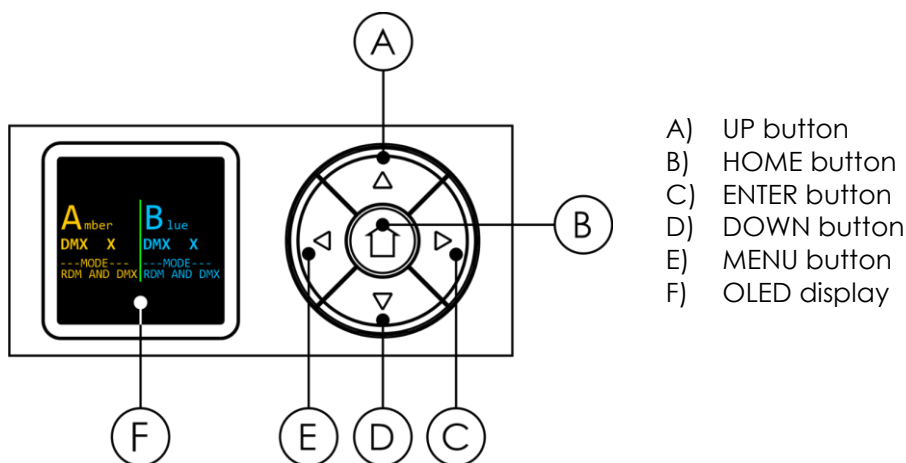

Fig. 09

- Use the **HOME** button to show the home screen.

- Use the **MENU** button to open the main menu, to exit the current submenu and to return to the main menu.
- Use the **UP/DOWN** buttons to navigate through the menus and to scroll through the available characters/numbers.
- Use the **ENTER** button to open the desired menu, to confirm your choice or to set the currently selected character/number.

## 6.4. Input Ports Monitoring

The device has 2 input ports: Input A (Amber) and Input B (Blue). The status of the input ports is shown on the display. The information about Input A is displayed in amber color and the information about Input B in blue. The information is available on the home screen or it can be accessed via the input port buttons and via the main menu.

### 6.4.1. Home Screen

The home screen provides side by side information about the connection status of Input A and Input B and the port mode. Press the **HOME** button to access the home screen.

Home screen examples:

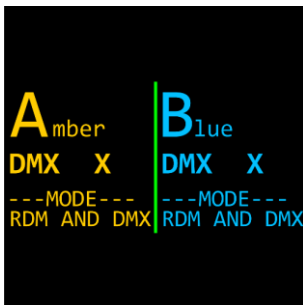

Input A (Amber):

- DMX signal: (X) not present
- Mode: RDM and DMX

Input B (Blue):

- DMX signal: (X) not present
- Mode: RDM and DMX

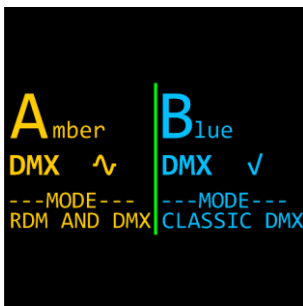

Input A (Amber):

- DMX signal: (~) weak/distorted
- Mode: RDM and DMX

Input B (Blue):

- DMX signal: (✓) present
- Mode: Classic DMX

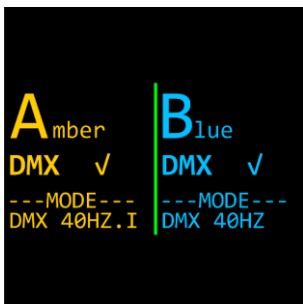

Input A (Amber):

- DMX signal: (✓) present
- Mode: DMX at 40 frames per second, frame integrity on

Input B (Blue):

- DMX signal: (✓) present
- Mode: DMX at 40 frames per second, frame integrity off

### 6.4.2. Quick Access

The **input port buttons (03)** and **(06)** provide quick access to the Status Information submenu for respectively Input A and Input B.

To view the status of Input A (Amber), press the **input port button (03)**. To view the status of Input B (Blue), press the **input port button (06)**. The screen provides information about the presence of DMX signal, the DMX channel and frame rate, the port mode and the assigned outputs to the respective input port.

To view the second screen with information, press the **UP/DOWN** buttons on the **control panel (11)**. The second screen provides information about the presence of DMX signal and the incoming DMX values at the respective input port.

See **6.9.1.3. Status Information** on pages 21–22 and **6.9.2.3. Status Information** on pages 23–24 for more information.

### 6.4.3. Access via the Main Menu

You can monitor the status of Input A and Input B from the main menu.

Refer to **6.9.1.3. Status Information** on pages 21–22 for monitoring the status of Input A.

Refer to **6.9.2.3. Status Information** on pages 23–24 for monitoring the status of Input B.

## 6.5. Output Ports Configuration

The device has 8 output ports. Each port can be assigned to Input A or Input B, or to both ports with the merge function. You can configure the output ports via the output port button or via the main menu.

### 6.5.1. Quick Access

The **output port buttons (09)** provide quick access to the configuration of the 8 output ports. Press the output port button repeatedly to select one of the following 3 configuration options:

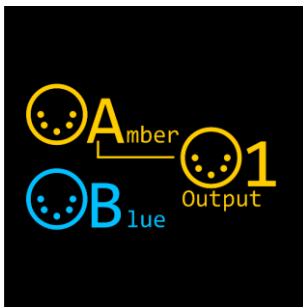

- Connect Output 1 to Input A.

The **LED indicator (10)**, located to the right of the port, will light in amber.

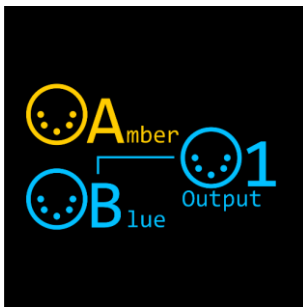

- Connect Output 1 to Input B.

The **LED indicator (10)**, located to the right of the port, will light in blue.

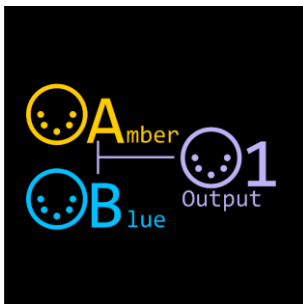

- Connect Output 1 to Input A and Input B via the merge function.

You can additionally configure the merging options via the main menu. Refer to **6.6. Merge Function** on page 16 for explanation of the configuration options and to **6.9.3. Merge** on pages 24–25 for the configuration settings.

The **LED indicator (10)**, located to the right of the port, will light in magenta.



### 6.5.2. Access via the Main Menu

You can configure the 8 output ports from the main menu. The configuration options are the same as via the quick access. Refer to **6.9.4. Outputs** on page 25 for more information.

## 6.6. Merge Function

The Booster Pro supports merging. Each output port can be configured to merge the DMX packets received at Input A and Input B. See **6.9.3. Merge** on pages 24–25 for the configuration settings.

The device supports the following merging modes:

### 6.6.1. HTP (Highest Takes Precedence)

When the HTP (Highest Takes Precedence) mode is selected, the DMX packets received at Input A and Input B are compared and the DMX packet with the highest value is sent to the respective output port.

For example, if a lighting controller, connected to Input A, sends a dimmer value at 50 % and a lighting controller, connected to Input B, sends a dimmer value at 80 %, at the output port there will be send 80 %. If you change the dimmer value at Input B to 0 %, the output value will be 50 %, sent by Input A, as 50 % is a higher value than 0 %.

HTP mode is recommended for controlling light intensity.

### 6.6.2. LTP (Latest Takes Precedence)

If you need to control parameters as color, pan and tilt, HTP mode will be a problem, as non-intensity channels do not have 'higher' or 'lower' values. The color red is not higher or lower than green, and gobo 1 is not higher or lower than gobo 2. Therefore, when working with effect lights or moving lights, it is recommended to use LTP (Latest Takes Precedence) mode.

The LTP (Latest Takes Precedence) mode means that the most recently received DMX packet from Input A and Input B will be sent to the respective output port.

For example, with two lighting controllers connected (Input A and B), the last lighting controller that made any change will take precedence and will control the output.

### 6.6.3. A + B

With A + B mode the DMX channel is split into 2 parts. The first part is reserved for Input A and the second part is reserved for Input B. The DMX packets received at the inputs are not combined. For example, Input A sends DMX packets up to channel 256 and Input B starts at channel 257 on the same universe. The starting address for Input B is user-programmable.

### 6.6.4. Backup

In backup mode Input A sends continuously DMX packets to the output. If Input A fails, Input B takes over automatically. Input B serves as a backup in case of failure of Input A.

## 6.7. LED Statuses

Each DMX input and output is provided with a LED indicator. The color of the LED for Input A is amber, and for Input B is blue.

The **LED indicator (04)** for Input A (Amber) has the following statuses:

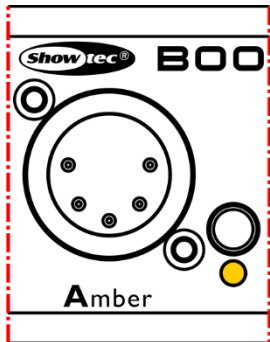

Fig. 10

- Steady: DMX signal is present at Input port A
- Flashing slowly: The Input A port is not selected and there is no DMX signal present at the port
- Flashing quickly: The Input A port is selected with the **input port button (03)** or via the menu
- Flashing red: DMX signal is faulty
- Flashing white: The port has received an RDM command to identify itself

The **LED indicator (07)** for Input B (Blue) has the following statuses:

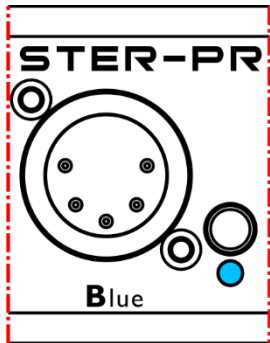

Fig. 11

- Steady: DMX signal is present at Input port B
- Flashing slowly: The Input B port is not selected and there is no DMX signal present at the port
- Flashing quickly: The Input B port is selected with the **input port button (06)** or via the menu
- Flashing red: DMX signal is faulty
- Flashing white: The port has received an RDM command to identify itself

The **LED indicators (10)** for the output ports have the following statuses:

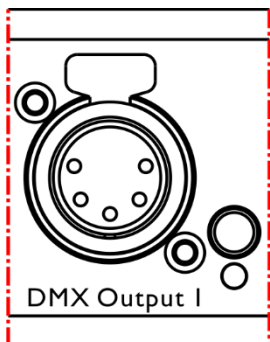
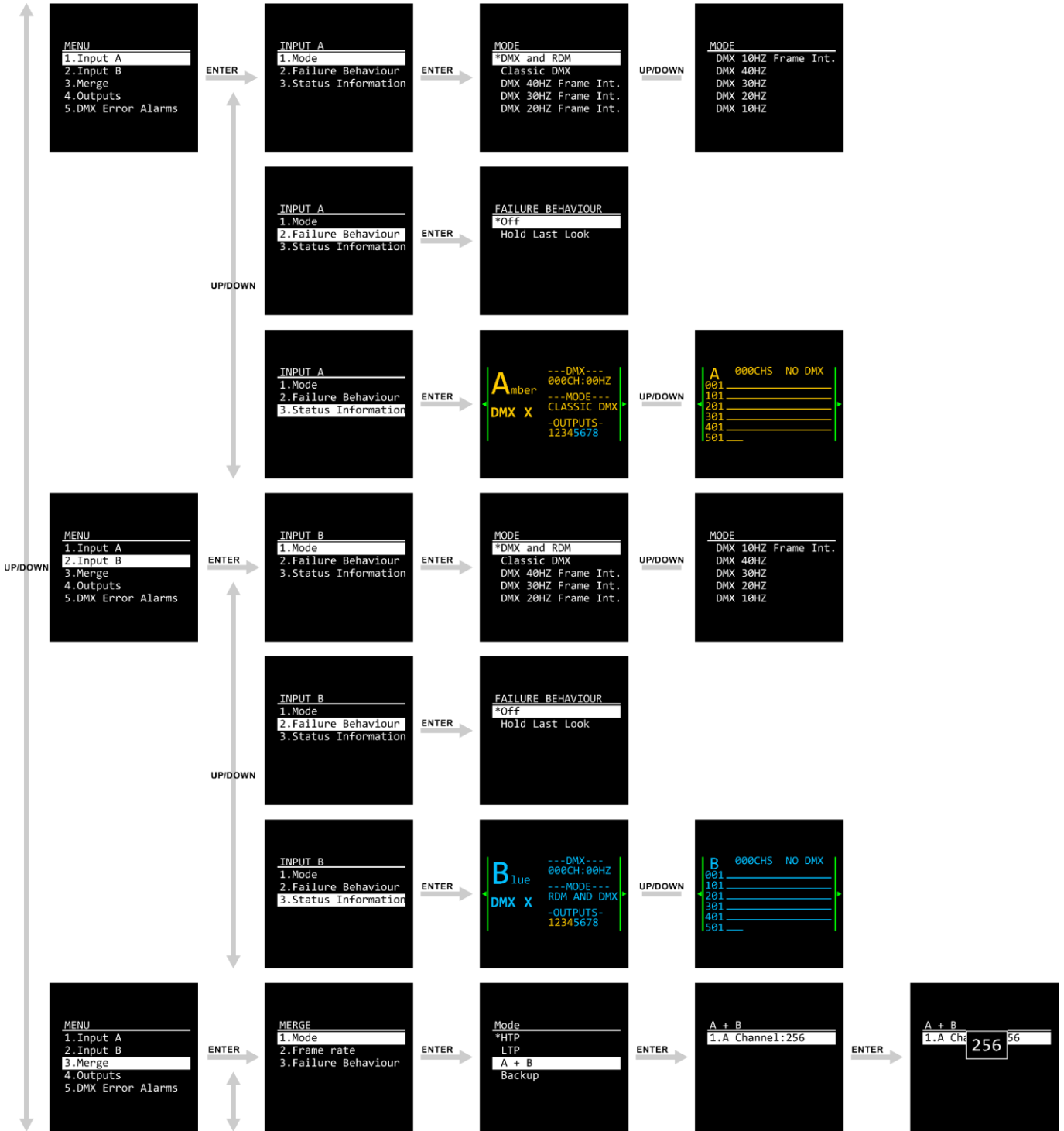
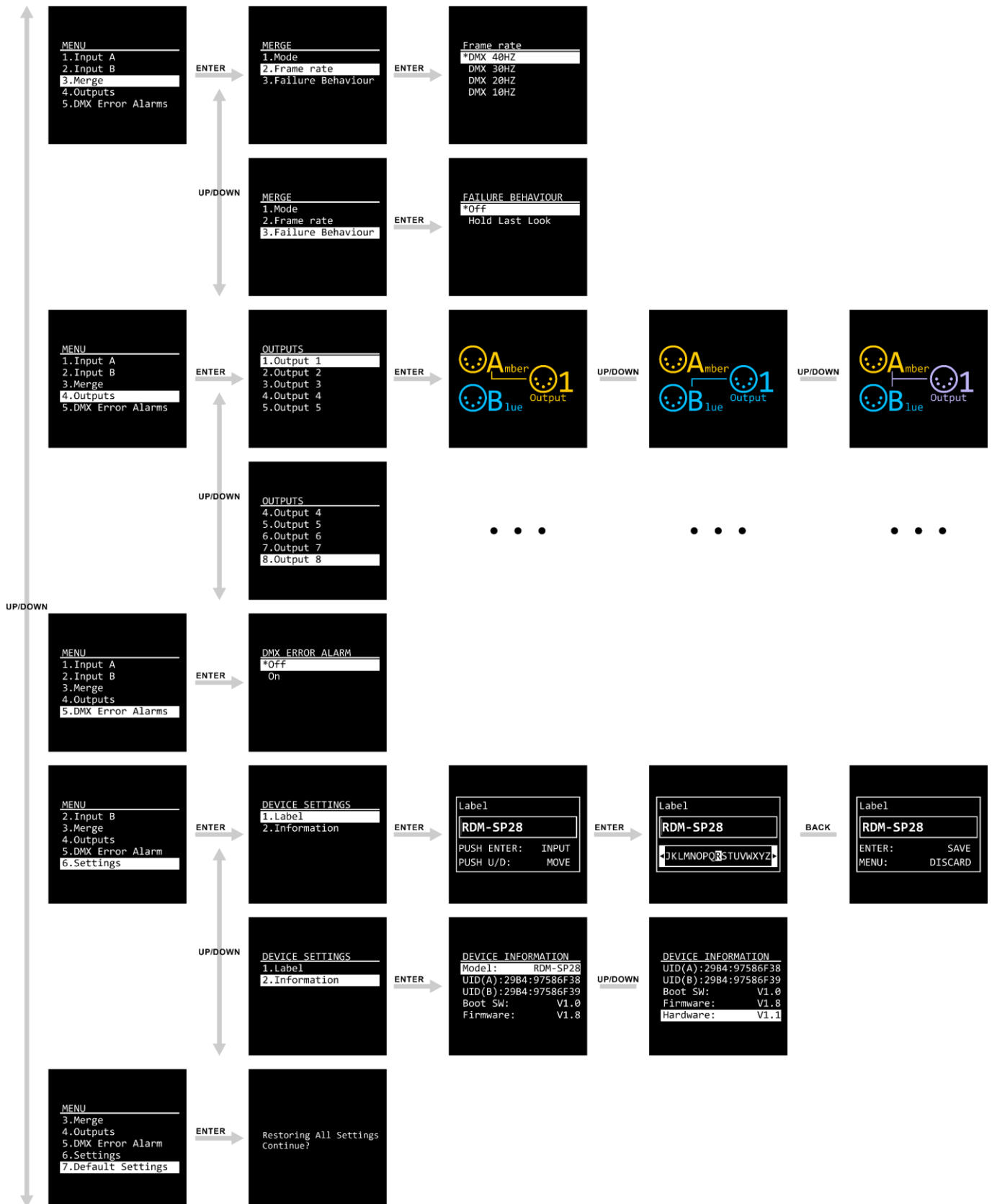

Fig. 12

- Amber color: The output port is connected to Input A (Amber)
- Blue color: The output port is connected to Input B (Blue)
- Magenta color: The merge function for the output port is activated
- Steady: DMX signal is present at the output port
- Flashing slowly: The output port is not selected and there is no DMX signal present at the port
- Flashing quickly: The output port is selected with the **output port button (09)** or via the menu
- Flashing white: The port has received an RDM command to identify itself

### 6.8. Menu Overview





## 6.9. Main Menu Options

The main menu has the following options:

```
MENU
1.Input A
2.Input B
3.Merge
4.Outputs
5.DMX Error Alarms
6.Settings
7.Default Settings
```

- 01) Press the **UP/DOWN** buttons to navigate through the main menu.
- 02) Press the **ENTER** button to open the submenus.

**Note:**

Currently active selections are marked with an asterisk (\*), for example:

```
FAILURE BEHAVIOUR
*Off
Hold Last Look
```

### 6.9.1. Input A

In this menu you can configure the settings and monitor the status of Input A (Amber).

- 01) Press the **UP/DOWN** buttons to select one of the following 3 options:

```
INPUT A
1.Mode
2.Failure Behaviour
3.Status Information
```

- Mode: See **6.9.1.1. Mode** for more information
- Failure Behaviour: See **6.9.1.2. Failure Behavior** for more information
- Status Information: See **6.9.1.3. Status Information** for more information

- 02) Press the **ENTER** button to confirm the selection.

#### 6.9.1.1. Mode

In this submenu you can configure the port mode and the frame rate.

- 01) Press the **UP/DOWN** buttons to select one of the following 10 options:

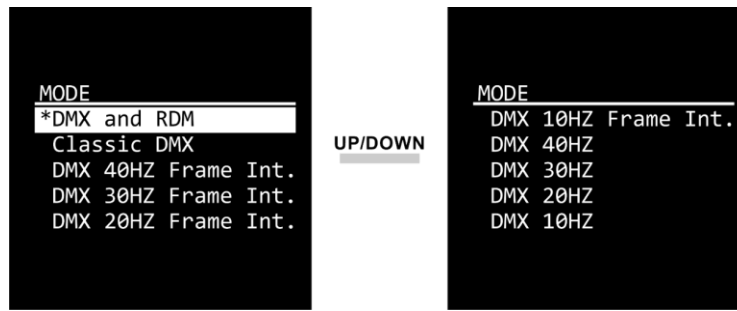

- DMX and RDM: The device functions as a bidirectional RDM splitter
- Classic DMX: The device only receives and forwards DMX data. The RDM function is disabled
- DMX 40HZ Frame Int.: DMX at 40 frames per second, frame integrity is on
- DMX 30HZ Frame Int.: DMX at 30 frames per second, frame integrity is on
- DMX 20HZ Frame Int.: DMX at 20 frames per second, frame integrity is on
- DMX 10HZ Frame Int.: DMX at 10 frames per second, frame integrity is on
- DMX 40HZ: DMX at 40 frames per second, frame integrity is off
- DMX 30HZ: DMX at 30 frames per second, frame integrity is off
- DMX 20HZ: DMX at 20 frames per second, frame integrity is off
- DMX 10HZ: DMX at 10 frames per second, frame integrity is off

**Note:**

If the frame integrity is on, the DMX packets retain exactly the same content and properties, including timing parameters, throughout the transmission process. No partially updated DMX packets are sent out.

02) Press the **ENTER** button to confirm the selection.

**6.9.1.2. Failure Behavior**

In this submenu you can set the behavior of the device in case of a DMX failure.

01) Press the **UP/DOWN** buttons to select one of the following 2 options:



- Off: The device will black out the output
- Hold Last Look: The device will use the last working DMX value on the output

02) Press the **ENTER** button to confirm the selection.

**6.9.1.3. Status Information**

In this submenu you can monitor the status of Input A.

Press the **UP/DOWN** buttons to toggle between the following 2 screens:

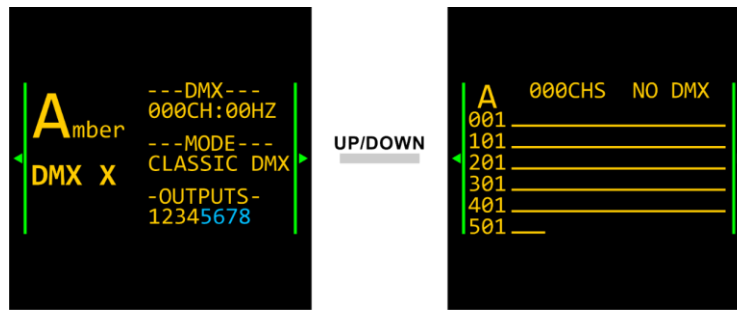

The first screen provides information about the presence of DMX signal, the DMX channel and frame rate, the port mode and the outputs assigned to Input A and Input B.

The second screen provides information about the presence of DMX signal and the incoming DMX values at Input A.

**Note:**

You can quickly access the status of the port with the **input port button (03)**. See **6.4. Input Ports Monitoring** on pages 14–15 for more information.

**6.9.2. Input B**

In this menu you can configure the settings and monitor the status of Input B (Blue).

01) Press the **UP/DOWN** buttons to select one of the following 3 options:

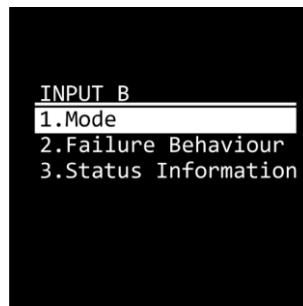

- Mode: See **6.9.2.1. Mode** for more information
- Failure Behaviour: See **6.9.2.2. Failure Behavior** for more information
- Status Information: See **6.9.2.3. Status Information** for more information

02) Press the **ENTER** button to confirm the selection.

**6.9.2.1. Mode**

In this submenu you can configure the port mode and the frame rate.

01) Press the **UP/DOWN** buttons to select one of the following 10 options:

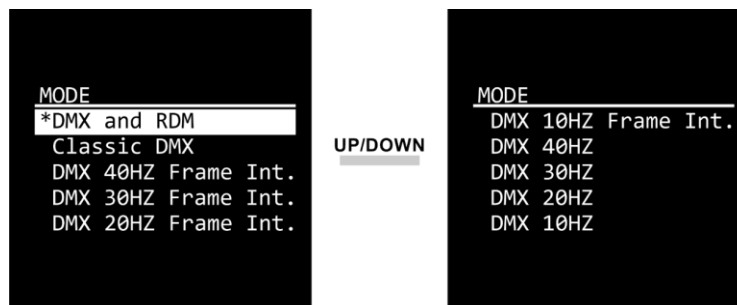

- DMX and RDM: The device functions as a bidirectional RDM splitter
- Classic DMX: The device only receives and forwards DMX data. The RDM function is disabled

- DMX 40HZ Frame Int.: DMX at 40 frames per second, frame integrity is on
- DMX 30HZ Frame Int.: DMX at 30 frames per second, frame integrity is on
- DMX 20HZ Frame Int.: DMX at 20 frames per second, frame integrity is on
- DMX 10HZ Frame Int.: DMX at 10 frames per second, frame integrity is on
- DMX 40HZ: DMX at 40 frames per second, frame integrity is off
- DMX 30HZ: DMX at 30 frames per second, frame integrity is off
- DMX 20HZ: DMX at 20 frames per second, frame integrity is off
- DMX 10HZ: DMX at 10 frames per second, frame integrity is off

**Note:**

If the frame integrity is on, the DMX packets retain exactly the same content and properties, including timing parameters, throughout the transmission process. No partially updated DMX packets are sent out.

02) Press the **ENTER** button to confirm the selection.

**6.9.2.2. Failure Behavior**

In this submenu you can set the behavior of the device in case of a DMX failure.

01) Press the **UP/DOWN** buttons to select one of the following 2 options:



- Off: The device will black out the output
- Hold Last Look: The device will use the last working DMX value on the output

02) Press the **ENTER** button to confirm the selection.

**6.9.2.3. Status Information**

In this submenu you can monitor the status of Input B.

Press the **UP/DOWN** buttons to toggle between the following 2 screens:

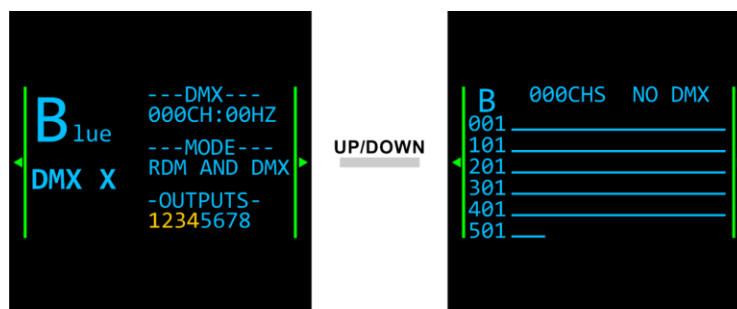

The first screen provides information about the presence of DMX signal, the DMX channel and frame rate, the port mode and the outputs assigned to Input A and Input B.

The second screen provides information about the presence of DMX signal and the incoming DMX values at Input B.



**Note:**

You can quickly access the status of the port with the **input port button (06)**. See **6.4. Input Ports Monitoring** on page 14–15 for more information.

**6.9.3. Merge**

In this menu you can configure the merging options.

01) Press the **UP/DOWN** buttons to select one of the following 3 options:

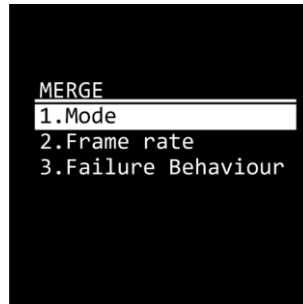

- Mode: See **6.9.3.1. Mode** for more information
- Frame rate: Select the frame rate. There are 4 options available: DMX 40 Hz, DMX 30 Hz, DMX 20 Hz and DMX 10 Hz
- Failure Behaviour: See **6.9.3.2. Failure Behavior** for more information

02) Press the **ENTER** button to confirm the selection.

**6.9.3.1. Mode**

In this submenu you can select the merging mode. See **6.6. Merge Function** on page 16 for more information.

01) Press the **UP/DOWN** buttons to select one of the following 4 options:

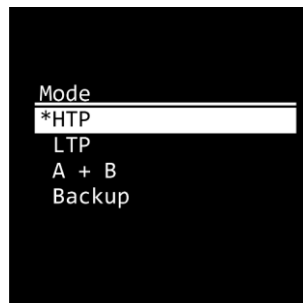

- HTP
- LTP
- A + B: Select the last channel for Input A. The remaining channels from the 512 channels in total will be used for Input B
- Backup

02) Press the **ENTER** button to confirm the selection.

### 6.9.3.2. Failure Behavior

In this submenu you can set the behavior of the device in case of a DMX failure.

01) Press the **UP/DOWN** buttons to select one of the following 2 options:



- Off: The device will black out the output
  - Hold Last Look: The device will use the last working DMX value on the output
- 02) Press the **ENTER** button to confirm the selection.

### 6.9.4. Outputs

In this menu you can configure the 8 outputs.

- 01) Press the **UP/DOWN** buttons to select the output which you want to configure.  
 02) Press the **ENTER** button to confirm the selection.  
 03) Press the **UP/DOWN** buttons repeatedly to choose one of the following 3 configuration options:

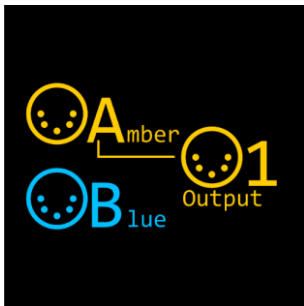

Connect Output 1 to Input A. The **LED indicator (10)**, located to the right of the port, will light in amber.

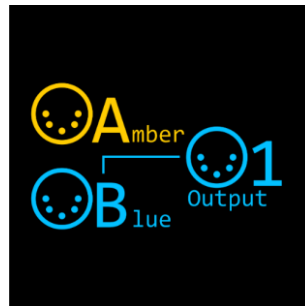

Connect Output 1 to Input B. The **LED indicator (10)**, located to the right of the port, will light in blue.

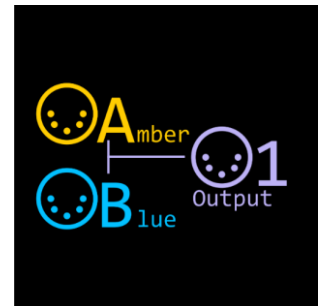

Connect Output 1 to Input A and Input B via the merge function. The **LED indicator (10)**, located to the right of the port, will light in magenta.

04) Press the **ENTER** button to confirm the selection.

**Note:**

- You can quickly configure the output ports with the **output port buttons (09)**. See **6.5. Output Ports Configuration** on pages 15–16 for more information.
- If the merge function is activated, the RDM is not functional.

### 6.9.5. DMX Error Alarm

In this menu you can activate the sound alarm in case of a DMX error.

01) Press the **UP/DOWN** buttons to toggle between Off and On:

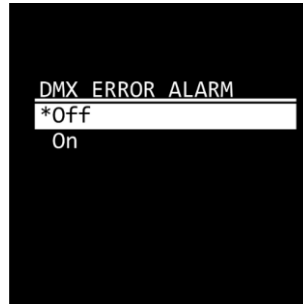

02) Press the **ENTER** button to confirm your choice.

### 6.9.6. Settings

In this menu you can change the name of the device and view the device's parameters.

01) Press the **UP/DOWN** buttons to choose between the following 2 options:

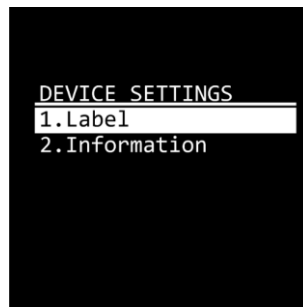

- Label: See **6.9.6.1. Label** for more information
- Information: See **6.9.6.2. Information** for more information

02) Press the **ENTER** button to confirm your choice.

#### 6.9.6.1. Label

In this submenu you can change the name of the device.

01) Press the **ENTER** button to enter edit mode. The cursor appears in front of the first character.

02) Press the **UP/DOWN** buttons to select the new character. The available characters are lowercase and uppercase letters, digits, punctuation marks, and some symbols.



03) Press the **ENTER** button to confirm your choice.

04) Press the **UP/DOWN** buttons to move the cursor respectively to the left or right to select the next character.

05) Repeat steps 2–4 to edit the rest of the characters. The maximum length of the name is 14 characters.

- 06) Press the **MENU** button to exit edit mode.
- 07) Press the **ENTER** button to confirm the changes or the **MENU** button to discard the changes.



## 6.9.6.2. Information

In this submenu you can view the device's parameters.

Press the **UP/DOWN** buttons to toggle between the following 2 screens.

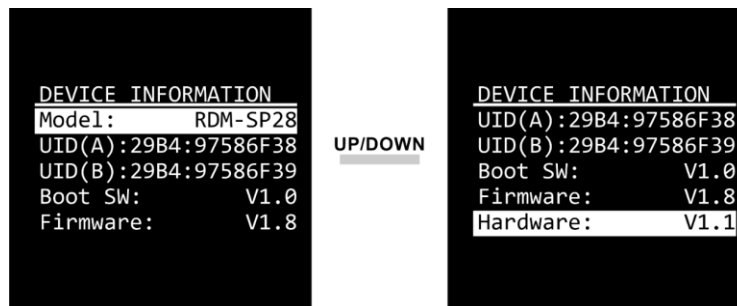

The available information is:

- Model
- UID (A): Unique Identification Number of Input A
- UID (B): Unique Identification Number of Input B
- Boot SW: Boot software
- Firmware
- Hardware

## 6.9.7. Set Default

In this menu you can reset the device's settings to the default factory settings.

Press the **ENTER** button to confirm the reset, when prompted, or press the **MENU** button to cancel the reset.



## 7. Troubleshooting

This troubleshooting guide contains solutions to problems which can be carried out by an ordinary person. The device does not contain user-serviceable parts.

Unauthorized modifications to the device will render the warranty void. Such modifications may result in injuries and material damage.

Refer servicing to instructed or skilled persons. Contact your Highlite International dealer in case the solution is not described in the table.

Problem	Probable cause(s)	Solution
The device does not function at all	No power to the device	<ul style="list-style-type: none"> <li>Check if power is switched on and cables are plugged in</li> </ul>
	Main fuse is blown	<ul style="list-style-type: none"> <li>Replace the fuse. See <b>8.3.1. Replacing the Fuse</b> on page 29</li> </ul>
No DMX data transfer	The factory settings of the device are changed	<ul style="list-style-type: none"> <li>Reset the device's parameters to the default factory settings. See <b>6.9.7. Set Default</b> on page 27</li> </ul>
	Bad data link connection	<ul style="list-style-type: none"> <li>Examine connections and cables. Correct poor connections. Repair or replace damaged cables</li> </ul>
	The signal is reversed. The 5-pin DMX OUT of the controller does not match the DMX IN of the device	<ul style="list-style-type: none"> <li>Install a phase-reversing cable between the controller and the device</li> </ul>
	The last device on the data link before the input is defective	<ul style="list-style-type: none"> <li>Remove or replace the last device on the data link before the input and check if normal operation is restored</li> </ul>

## 8. Maintenance

### 8.1. Safety Instructions for Maintenance



**DANGER**  
Electric shock caused by dangerous voltage inside

Disconnect power supply before servicing or cleaning.

### 8.2. Preventive Maintenance



**Attention**  
Before use, examine the device visually for any defects.

Make sure that:

- All screws used for installing the device or parts of the device are tightly fastened and are not corroded.
- There are no deformations on housings, fixations and installation points.
- The power cables are not damaged and do not show any material fatigue.

### 8.2.1. Basic Cleaning Instructions

To clean the device, follow the steps below:

- 01) Disconnect the device from the electrical power supply.
- 02) Allow the device to cool down for 5 minutes.
- 03) Clean the device with a soft, lint-free cloth.



#### **Attention**

- Do not immerse the device in liquid.
- Do not use alcohol or solvents.

### 8.3. Corrective Maintenance

The device does not contain user-serviceable parts. Do not open the device and do not modify the device.

Refer repairs and servicing to instructed or skilled persons. Contact your Highlite International dealer for more information.

#### 8.3.1. Replacing the Fuse



#### **DANGER** **Electric shock caused by short-circuit**

- Do not bypass the thermostatic switch or fuses.
- For replacement use fuses of the same type and rating only.

Power surges, short-circuit or incorrect electrical power supply may cause a fuse to burn out. If the fuse burns out, the device will not function anymore. If this happens, follow the steps below:

- 01) Disconnect the device from the electrical power supply.
- 02) Allow the device to cool down for 5 minutes.
- 03) Loosen the fuse cover with a screwdriver and remove the fuse holder.
- 04) If the fuse is brown or unclear, it is burned out. Remove the old fuse.
- 05) Insert a new fuse in the fuse holder. Make sure that the type and the rating of the replacement fuse are the same as the ones specified on the information label of the product.
- 06) Replace the fuse holder in the opening and tighten the fuse cover.

## 9. Deinstallation, Transportation and Storage

---

- Disconnect power supply before deinstallation.
- Use the original packaging to transport the device, if possible.
- Clean the device before storing. Follow the cleaning instructions in chapter **8.2.1. Basic Cleaning Instructions** on page 29.
- Store the device in the original packaging, if possible.

## 10. Disposal

---

### Correct disposal of this product



Waste Electrical and Electronic Equipment

This symbol on the product, its packaging or documents indicates that the product shall not be treated as household waste. Dispose of this product by handing it to the respective collection point for recycling of electrical and electronic equipment. This is to avoid environmental damage or personal injury due to uncontrolled waste disposal. For more detailed information about recycling of this product contact the local authorities or the authorized dealer.

## 11. Approval

---



Check the respective product page on the website of Highlite International ([www.highlite.com](http://www.highlite.com)) for an available declaration of conformity.



©2020 Showtec