

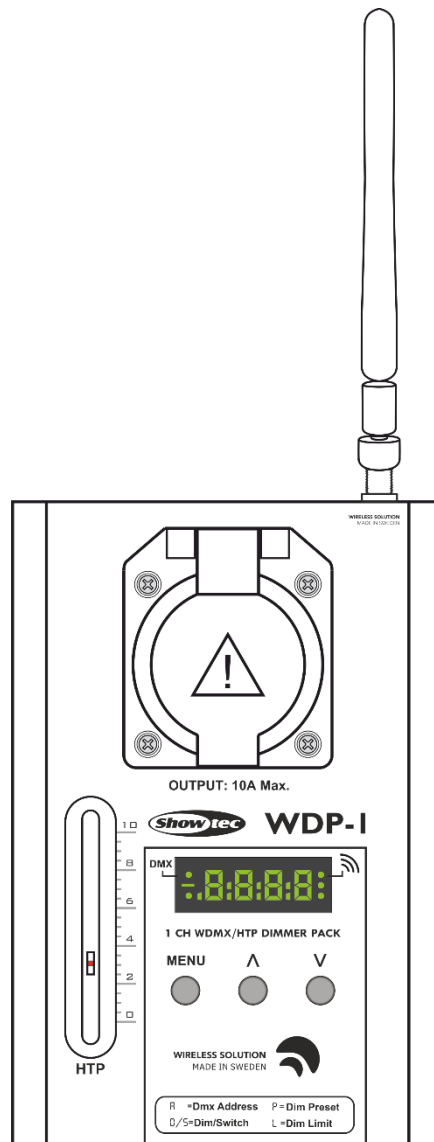

MANUAL



ENGLISH

Single WDP-1

V2

Ordercode: 50756

Table of contents

Warning	2
Safety Instructions	2
Operating Determinations	3
Connection with the mains.....	3
Return Procedure	4
Claims.....	4
Description of the device	5
Overview	5
HTP (Highest Takes Precedence)	6
Installation	6
Connection Example	6
Set Up and Operation	7
Linking.....	7
Wireless Status LED Indicator.....	7
Unlinking.....	7
Control Panel	8
Control Mode	8
DMX Addressing	8
Menu Overview	8
Main Menu Options	9
1. Remote Control/Manual Control	9
2. DMX Addressing (Fun1)	9
3. Dimmer/Switch (Fun1)	9
4. Dimmer Limit (Fun1)	9
5. WDP Control (Fun1)	9
6. Dimmer Preset (Fun2)	9
7. Full On (Fun2)	10
DMX Channels	10
1 channel	10
Maintenance	10
Replacing the Fuse	10
Troubleshooting	10
Product Specification	11
Notes	12

Warning



**For your own safety, please read this user manual carefully
before your initial start-up!**



Unpacking Instructions

Immediately upon receiving this product, carefully unpack the carton and check the contents to ensure that all parts are present, and have been received in good condition. Notify the dealer immediately and retain packing material for inspection if any parts appear damaged from shipping or the carton itself shows signs of mishandling. Save the carton and all packing materials. In the event that a fixture must be returned to the factory, it is important that the fixture be returned in the original factory box and packing.

Your shipment includes:

- Showtec Single WDP-1 with a power cable (1 m)
- Remote dimming fader with a power cable (1,9 m)
- User manual

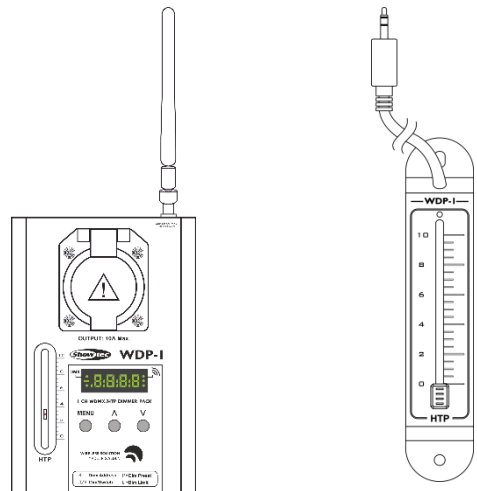

CAUTION!
Keep this device away from rain and moisture!
Unplug mains lead before opening the housing!



Safety Instructions

Every person involved with the installation, operation and maintenance of this device has to:

- be qualified
- follow the instructions of this manual



CAUTION! Be careful with your operations.
**With a dangerous voltage you can suffer
a dangerous electric shock when touching the wires!**



Before your initial start-up, please make sure that there is no damage caused by transportation. Should there be any, consult your dealer and do not use the device.

To maintain perfect condition and to ensure a safe operation, it is absolutely necessary for the user to follow the safety instructions and warning notes written in this manual.

Please consider that damages caused by manual modifications to the device are not subject to warranty.

This device contains no user-serviceable parts. Refer servicing to qualified technicians only.

IMPORTANT!

The manufacturer will not accept liability for any resulting damages caused by the non-observance of this manual or any unauthorized modification to the device.

- Never let the power cord come into contact with other cables! Handle the power cord and all connections with the mains with particular caution!
- Never remove warning or informative labels from the unit.
- Never leave any cables lying around.
- Do not insert objects into air vents.
- Do not open the device and do not modify the device.
- Do not connect this device to a dimmer pack.
- Do not shake the device. Avoid brute force when installing or operating the device.
- Do not switch the device on and off in short intervals, as this would reduce the system's life.
- Only use device indoors, avoid contact with water or other liquids.
- Only operate the device after having familiarized with its functions.
- Avoid flames and do not put close to flammable liquids or gases.
- Always disconnect power from the mains, when device is not used or before cleaning! Only handle the power cord by the plug. Never pull out the plug by tugging the power cord.
- Make sure that the device is not exposed to extreme heat, moisture or dust.
- Make sure that the available voltage is not higher than stated on the rear panel.
- Make sure that the power cord is never crimped or damaged. Check the device and the power cord from time to time.
- If device is dropped or struck, disconnect mains power supply immediately. Have a qualified engineer inspect for safety before operating.
- If the device has been exposed to drastic temperature fluctuation (e.g. after transportation), do not switch it on immediately. The arising condensation water might damage your device. Leave the device switched off until it has reached room temperature.
- If your Showtec device fails to work properly, discontinue use immediately. Pack the unit securely (preferably in the original packing material), and return it to your Showtec dealer for service.
- For adult use only. The device must be installed out of the reach of children. Never leave the unit running unattended.
- For replacement use fuses of same type and rating only.
- Repairs, servicing and electric connection must be carried out by a qualified technician.
- WARRANTY: Till one year after date of purchase.

Operating Determinations

- This device is not designed for permanent operation. Consistent operation breaks will ensure that the device will serve you for a long time without defects.
- The maximum ambient temperature $t_a = 35^\circ\text{C}$ must never be exceeded.
- The relative humidity must not exceed 50 % with an ambient temperature of 35°C .
- If this device is operated in any other way, than the one described in this manual, the product may suffer damages and the warranty becomes void.
- Any other operation may lead to dangers like short-circuit, burns, electric shock, crash etc.

You endanger your own safety and the safety of others!

Connection with the mains

Connect the device to the mains with the power-plug.

Always pay attention, that the right color cable is connected to the right place.

International	EU Cable	UK Cable	US Cable	Pin
L	BROWN	RED	YELLOW/COPPER	PHASE
N	BLUE	BLACK	SILVER	NEUTRAL
	YELLOW/GREEN	GREEN	GREEN	PROTECTIVE GROUND

Make sure that the device is always connected properly to the earth!

Improper installation can cause serious damage to people and property!

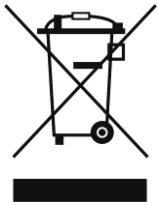

Return Procedure

Returned merchandise must be sent prepaid and in the original packing, call tags will not be issued. Package must be clearly labeled with a Return Authorization Number (RMA number). Products returned without an RMA number will be refused. Highlite will not accept the returned goods or any responsibility. Call Highlite 0031-455667723 or mail aftersales@highlite.com and request an RMA prior to shipping the fixture. Be prepared to provide the model number, serial number and a brief description of the cause for the return. Be sure to properly pack fixture, any shipping damage resulting from inadequate packaging is the customer's responsibility. Highlite reserves the right to use its own discretion to repair or replace product(s). As a suggestion, proper UPS packing or double-boxing is always a safe method to use.

Note: If you are given an RMA number, please include the following information on a piece of paper inside the box:

- 01) Your name
- 02) Your address
- 03) Your phone number
- 04) A brief description of the symptoms

Claims

The client has the obligation to check the delivered goods immediately upon delivery for any shortcomings and/or visible defects, or perform this check after our announcement that the goods are at their disposal. Damage incurred in shipping is the responsibility of the shipper; therefore the damage must be reported to the carrier upon receipt of merchandise.

It is the customer's responsibility to notify and submit claims with the shipper in the event that a fixture is damaged due to shipping. Transportation damage has to be reported to us within one day after receipt of the delivery.

Any return shipment has to be made post-paid at all times. Return shipments must be accompanied with a letter defining the reason for return shipment. Non-prepaid return shipments will be refused, unless otherwise agreed in writing.

Complaints against us must be made known in writing or by fax within 10 working days after receipt of the invoice. After this period complaints will not be handled anymore.

Complaints will only then be considered if the client has so far complied with all parts of the agreement, regardless of the agreement of which the obligation is resulting.

Description of the device

Features

The Showtec Single WDP-1 is a 1-channel DMX dimmer/switch with a built-in wireless DMX receiver. It is possible to mount the Single WDP-1 to any wall, truss or a fixture which makes it suitable for any location.

- Input voltage: 230V AC, 50Hz
- Output: 10A Schuko output
- Connections: 3-pin DMX signal connector IN/OUT
- 50 mm dimming fader
- Built-in wireless DMX receiver
- DMX channels: 1 channel
- Housing: Metal & flame retardant plastic
- Color: Grey
- Fuse: F10L/250V
- Dimensions: 100 x 95 x 273 mm (LxWxH)
- Weight: 1,4 kg

Optional accessories

[50175](#) – W-DMX™ Micro F-1 Transceiver

[50177](#) – W-DMX™ Blackbox F-1 G5 Transceiver

[50178](#) – W-DMX™ Blackbox F-2 G5 Transceiver

Overview

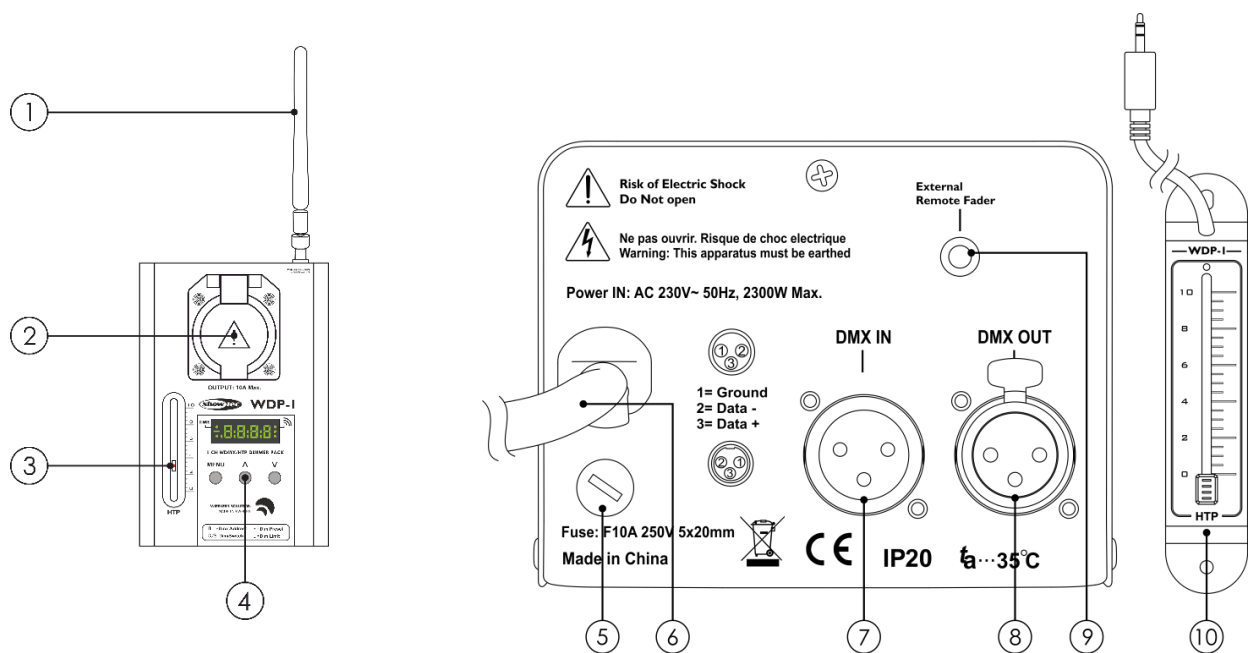

Fig. 01

- 01) **Wireless DMX antenna**
- 02) **10A Schuko OUT**
Connect a light source.
- 03) **Manual dimming fader (HTP)**
Move the fader up and down, to adjust the dimmer brightness.
- 04) **LED display + control buttons**
- 05) **Fuse F10L/250V**
- 06) **230V AC Schuko power cable (1 m)**
- 07) **3-pin DMX signal connector IN**
- 08) **3-pin DMX signal connector OUT**
- 09) **Remote dimming fader connector – 3,5 mm mini jack IN**
Connect the remote dimming fader (10).
- 10) **Remote dimming fader 1,9 m (HTP)**
Move the fader up and down to adjust the dimmer brightness.

HTP (Highest Takes Precedence)

If the DMX input value is higher than the fader (03/10) value, then the DMX input will take precedence over the fader input. Similarly, if the fader (03/10) value is higher than the DMX input value, then the fader input will take precedence over the DMX input.

Installation

Remove all packing materials from the Single WDP-1. Check if all foam and plastic padding is removed. Connect all cables.

Do not supply power before the whole system is set up and connected properly.

Always disconnect from electric mains power supply before cleaning or servicing.

Damages caused by non-observance are not subject to warranty.

Connection Example

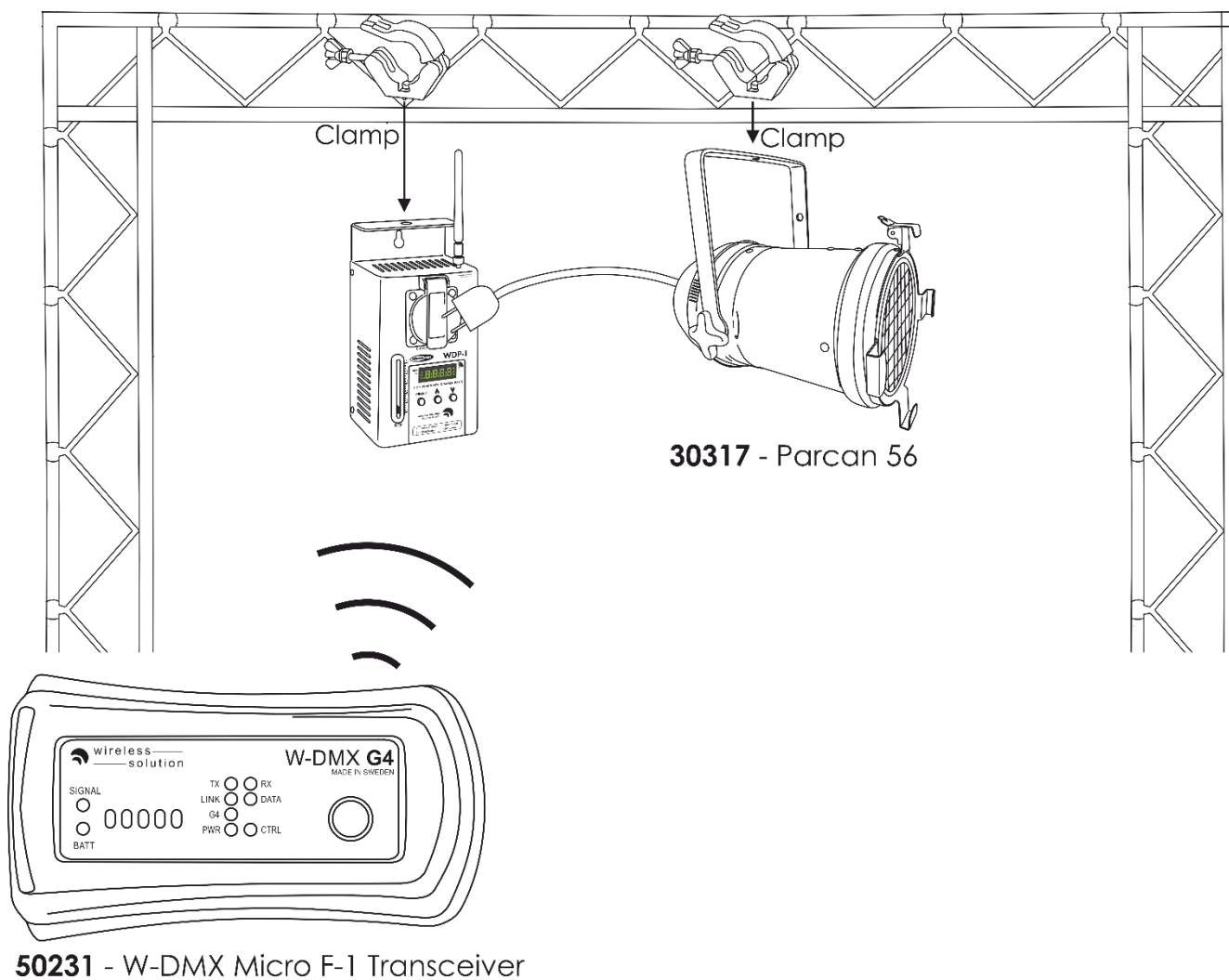

Fig. 02

Set Up and Operation

Follow the directions below, as they pertain to your preferred operation mode.

Before plugging the unit in, always make sure that the power supply matches the product specification voltage. Do not attempt to operate a 120V specification product on 230V power, or vice versa. Connect the device to the main power supply.

The Single WDP-1 is equipped with the power failure memory. This means that the device remembers the last active settings and operation mode and is able to restore them in case of a power shortage. The Single WDP-1 can be used as a dimmer pack or a switch pack.

Linking

- 01) In order to link the Single WDP-1 to a transmitter, you should follow the instructions from your transmitter's user manual. It is not possible to link devices from the Single WDP-1.
- 02) Make sure that the device is not linked to a transmitter.
- 03) Check the Wireless status LED (**F**) (see the control panel, page 8) and compare with the chart below (fig. 03).

Wireless Status LED Indicator

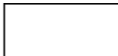
 = LED ON  = LED OFF

1) 

LED continuously off = the WDP-1 is not linked to any transmitter

2) 

LED is blinking slowly = the WDP-1 is linked to a transmitter, no DMX signal

3) 

LED is continuously on = the WDP-1 is linked to a transmitter, DMX signal received

4) 

LED is blinking quickly = linking in progress/connection terminated

Fig. 03

Unlinking

It is possible that, before being able to use the Single WDP-1, **you will need to unlink it first.** There are 2 ways of unlinking the Single WDP-1: via transmitter or via the Single WDP-1.

- 01) Via transmitter: Follow the instructions from your transmitter's user manual on how to unlink the devices.
- 02) Via the Single WDP-1: Press and hold down the **MENU** and **DOWN** buttons for 4 seconds. The Single WDP-1 will now be unlinked (the wireless status LED will switch off). Now, it is possible to link your transmitter to the Single WDP-1. To do so, follow the instructions from your transmitter's user manual.

Control Panel

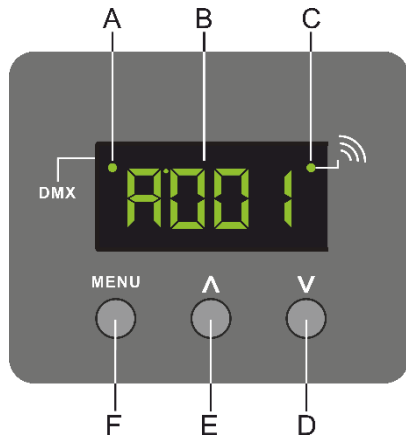

- A) DMX LED indicator
- B) LED display
- C) Wireless DMX LED indicator
- D) DOWN button
- E) UP button
- F) MENU button

Fig. 04

Control Mode

The Single WDP-1 is individually addressed on a data-link and connected to the controller. The fixtures respond to the DMX signal from the controller. (When you select the DMX address and save it, the controller will display the saved DMX address, next time.)

DMX Addressing

The control panel on the front side of the base allows you to assign DMX fixture addresses, which is the first channel with which the WDP will respond to the controller. Please note, when you use the controller, the unit has 1 channel.

Controlling:

After having addressed all WDP fixtures, you may now start operating these via your lighting controller.

Note: After switching on, the WDP will automatically detect whether DMX 512 data is received or not. If there is no data received at the DMX-input, the "LED " on the control panel will not flash.

If not, the problem may be:







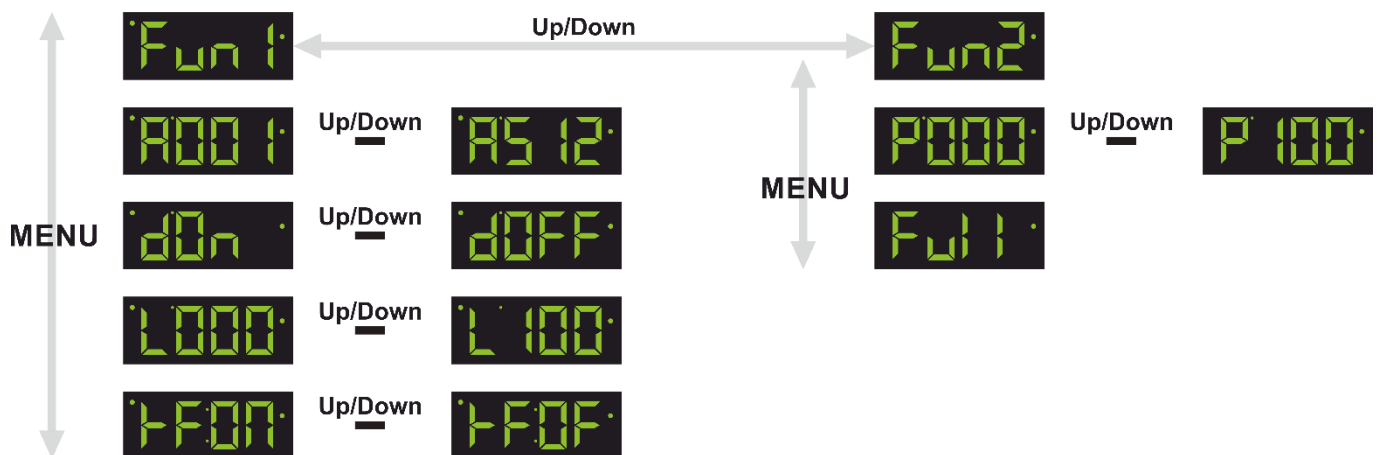











- The XLR cable from the controller is not connected with the input of the Single WDP-1.
- The controller is switched off or defective, the cable or connector is defective, or the signal wires are swapped in the input connector.

Note: It is necessary to insert an XLR termination plug (with 120 Ohm) in the last fixture in order to ensure proper transmission on the DMX data link.

Menu Overview



Main Menu Options



  	1. Remote control/Manual control
  	2. DMX Addressing (Fun1)
  	3. Dimmer/Switch (Fun1)
  	4. Dimmer Limit (Fun1)
  	5. WDP Control (Fun1)
  	6. Dimmer Preset (Fun2)
	7. Full On (Fun2)

1. Remote Control/Manual Control







- Press the **MENU** button until the display shows  or .
- Press the **UP/DOWN** buttons to choose between  (DMX/wireless DMX receiver enabled) and  (manual mode).

Note: If you have chosen , please read sections 2-5.
If you have chosen , please read sections 6-7.

2. DMX Addressing (Fun1)

- Press the **MENU** button until the display shows   .
- Press the **UP/DOWN** buttons to choose the desired DMX address. The adjustment range is between 001-512. Press and hold down the **UP/DOWN** buttons for fast DMX address selection.
- The currently selected DMX address will be automatically saved.

3. Dimmer/Switch (Fun1)

- Press the **MENU** button until the display shows   .
- Press the **UP/DOWN** buttons to choose between  and .
- If set to , then it is possible to remotely dim the light output.
- If set to , then it is possible to switch the light output on/off.





4. Dimmer Limit (Fun1)

- Press the **MENU** button until the display shows   .
- Press the **UP/DOWN** buttons to set the desired maximum dimming limit value. The adjustment range is between 0-100.

5. WDP Control (Fun1)

- Press the **MENU** button until the display shows   .
- Press the **UP/DOWN** buttons to choose between  (controlled by wireless DMX) and  (controlled by XLR DMX).

6. Dimmer Preset (Fun2)

- Once you have set the device to  (see section 1 above), press the **MENU** button.
- The display will show   .
- Press the **UP/DOWN** buttons to set the desired dimmer value. The adjustment range is between 0-100, from dark to brightest.

7. Full On (Fun2)

- 01) Once you have set the device to **Fun2** (see section 1), press the **MENU** button until the display shows **Full**.
- 02) The dimmer is now set to its maximum value (full on). It is not possible to adjust any settings.

DMX Channels

1 channel

Channel 1 – Dimmer intensity

0-255 From dark to brightest

Maintenance

The operator has to make sure that safety-related and machine-technical installations are to be inspected by an expert after every year in the course of an acceptance test.

The operator has to make sure that safety-related and machine-technical installations are to be inspected by a skilled person once a year.

The following points have to be considered during the inspection:

- 01) All screws used for installing the device or parts of the device have to be tightly connected and must not be corroded.
- 02) There may not be any deformations on housings, fixations and installation spots.
- 03) The electric power supply cables must not show any damages or material fatigue.

The Single WDP-1 requires almost no maintenance. However, you should keep the unit clean.

Disconnect the mains power supply, and then wipe the cover with a damp cloth. Do not immerse in liquid. Keep connections clean. Disconnect electric power, and then wipe the DMX connections with a damp cloth. Make sure connections are thoroughly dry before linking equipment or supplying electric power.

Replacing the Fuse

Power surges, short-circuit or inappropriate electrical power supply may cause a fuse to burn out. If the fuse burns out, the product will not function whatsoever. If this happens, follow the directions below.

- 01) Unplug the unit from electric power source.
- 02) Insert a screwdriver into the fuse holder. Turn the fuse holder counterclockwise. The fuse holder will come out.
- 03) Remove the used fuse. If brown or unclear, it is burned out.
- 04) Insert the replacement fuse into the holder where the old fuse was. Reinsert the fuse holder. Be sure to use a fuse of the same type and specification. See the product specification label for details.

Troubleshooting

This troubleshooting guide is meant to help solve simple problems. If a problem occurs, carry out the steps below in sequence until a solution is found. Once the unit operates properly, do not carry out the following steps.

Suspect two potential problem areas as: the power supply and the fuse.

- 01) Power supply. Check if the unit is plugged into an appropriate power supply.
- 02) The fuse. Replace the fuse. See page 10 for replacing the fuse.
- 03) If both appear to be O.K., plug the unit in again.
- 04) If you are unable to determine the cause of the problem, do not open the Single WDP-1, as this may damage the unit and the warranty will become void.
- 05) Return the device to your Showtec dealer.

Product Specification

Model:	Showtec Single WDP-1
Input voltage:	230V AC, 50Hz
Fuse:	F10L/250V
Dimensions:	100 x 95 x 273 mm (LxWxH)
Weight:	1,4 kg
Operation	
Signal input:	3-pin DMX IN
Signal output:	3-pin DMX OUT
Output:	10A Schuko
Electro-mechanical effects	
Housing:	Metal & flame retardant plastic
Color:	Grey
Control:	50 mm dimming fader
Voltage and amperage indication:	LED display
Max. ambient temperature t_a :	-5°C-35°C
Max. housing temperature t_B :	80°C
Minimum distance:	
Minimum distance from flammable surfaces:	0,5 m

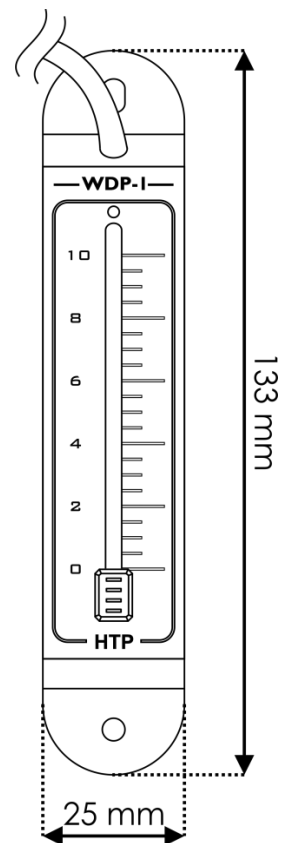
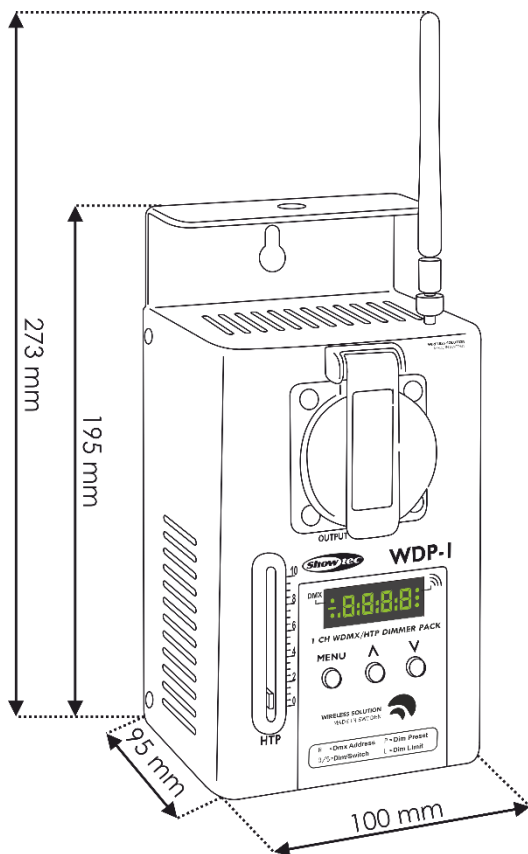

Design and product specifications are subject to change without prior notice.



Website: www.Showtec.info
 Email: service@highlite.com



©2020 Showtec