

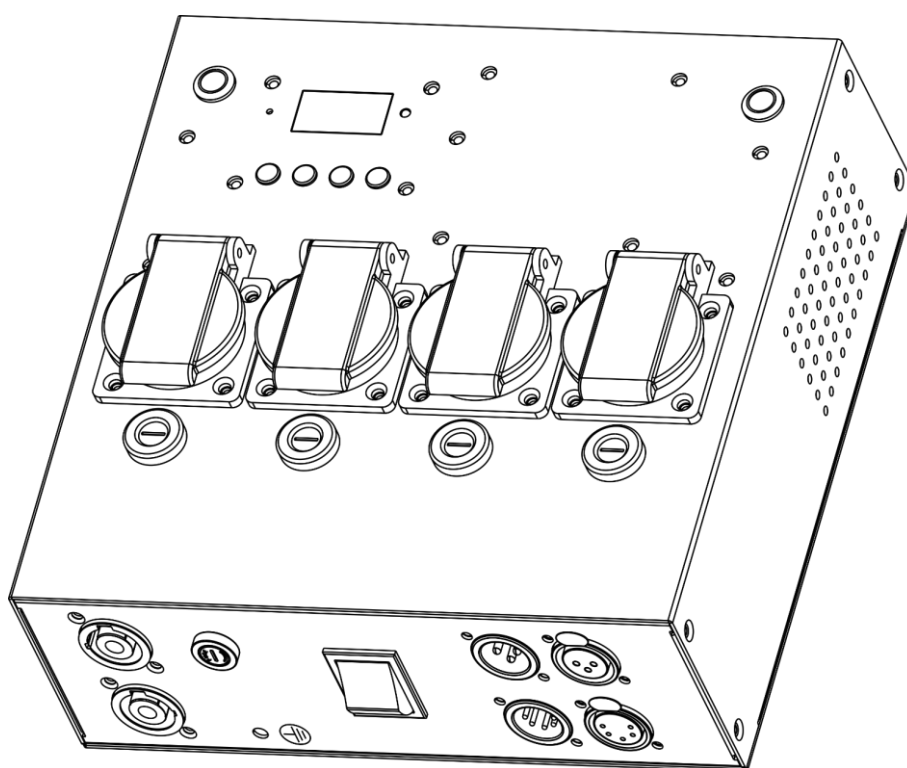

USER MANUAL



ENGLISH

TED Pack

V1

Product code: 50446

Preface

Thank you for purchasing this Showtec product.

The purpose of this user manual is to provide instructions for the correct and safe use of this product.

Keep the user manual for future reference as it is an integral part of the product. The user manual shall be stored at an easily accessible location.

This user manual contains information concerning:

- Safety instructions
- Intended and non-intended use of the device
- Installation and operation of the device
- Maintenance procedures
- Troubleshooting
- Transport, storage and disposal of the device

Non-observance of the instructions in this user manual may result in serious injuries and damage of property.

©2022 Showtec. All rights reserved.

No part of this document may be copied, published or otherwise reproduced without the prior written consent of Highlite International.

Design and product specifications are subject to change without prior notice.

For the latest version of this document or other language versions, please visit our website www.highlite.com or contact us at service@highlite.com.

Highlite International and its authorized service providers are not liable for any injury, damage, direct or indirect loss, consequential or economic loss or any other loss arising from the use of, or inability to use or reliance on the information contained in this document.

Table of contents

1. Introduction.....	4
1.1. Before Using the Product	4
1.2. Intended Use	4
1.3. Text Conventions	4
1.4. Acronyms and Abbreviations	4
1.5. Symbols and Signal Words.....	5
1.6. Symbols on the Information Label	5
2. Safety	6
2.1. Warnings and Safety Instructions	6
2.2. Requirements for the User.....	8
3. Description of the Device	9
3.1. Front View	9
3.2. Bottom View	9
3.3. Back View	10
3.4. Top View	10
3.5. Product Specifications	11
3.6. Dimensions.....	12
4. Installation	12
4.1. Safety Instructions for Installation	12
4.2. Personal Protective Equipment	12
4.3. Installation Site Requirements	12
4.4. Rigging	13
4.5. Connecting to Power Supply.....	14
4.6. Power Linking of Multiple Devices.....	14
5. Setup	15
5.1. Warnings and Precautions	15
5.2. DMX Connection.....	15
5.2.1. DMX-512 Protocol	15
5.2.2. DMX Cables.....	15
5.2.3. DMX Linking.....	16
5.3. Connecting Fixtures	16
5.4. Setup Example	17
6. Operation	18
6.1. Safety Instructions for Operation.....	18
6.2. Trailing-edge Dimming vs. Leading-edge Dimming.....	18
6.2.1. Trailing-edge Dimming	18
6.2.2. Leading-edge Dimming.....	19
6.3. Operation Modes.....	19
6.3.1. Dimmer Mode	19
6.3.2. Switch Mode.....	19
6.3.3. FX Mode	20
6.3.4. Auto Mode.....	20
6.4. Control Panel	21
6.5. Start-up.....	21
6.6. Menu Overview	22
6.7. Main Menu Options	24
6.7.1. DMX Address	24
6.7.2. DMX Person.....	24
6.7.3. Information.....	25
6.7.4. Status.....	25
6.7.5. Dimming Mode	25
6.7.6. Minimum Output.....	26
6.7.7. Maximum Output	26

6.7.8.	Curve	26
6.7.9.	Manual.....	27
6.7.10.	Chase	27
6.7.11.	DMX Fail.....	28
6.7.12.	Dimmer Speed	28
6.7.13.	Display OFF	28
6.7.14.	Display Invert	28
6.7.15.	Factory Reset.....	28
6.8.	DMX Channels	29
6.9.	RDM Information.....	29
6.9.1.	RDM Details.....	29
6.9.2.	Supported RDM PIDs for the Device	30
6.9.3.	Supported RDM PIDs for the SubDevices	30
7.	Troubleshooting	31
8.	Maintenance	32
8.1.	Safety Instructions for Maintenance.....	32
8.2.	Preventive Maintenance	32
8.2.1.	Basic Cleaning Instructions	32
8.3.	Corrective Maintenance	33
8.3.1.	Replacing the Fuse.....	33
9.	Deinstallation, Transportation and Storage	34
9.1.	Instructions for Deinstallation.....	34
9.2.	Instructions for Transportation	34
9.3.	Storage	34
10.	Disposal	34
11.	Approval.....	34

1. Introduction

1.1. Before Using the Product



Important
Read and follow the instructions in this user manual before installing, operating or servicing this product.

The manufacturer will not accept liability for any resulting damages caused by the non-observance of this manual.

After unpacking, check the contents of the box. If any parts are missing or damaged, contact your Highlite International dealer.

Your shipment includes:

- Showtec TED Pack
- Quick lock bracket
- Schuko to Seetronic power cable (1,5 m)
- User manual

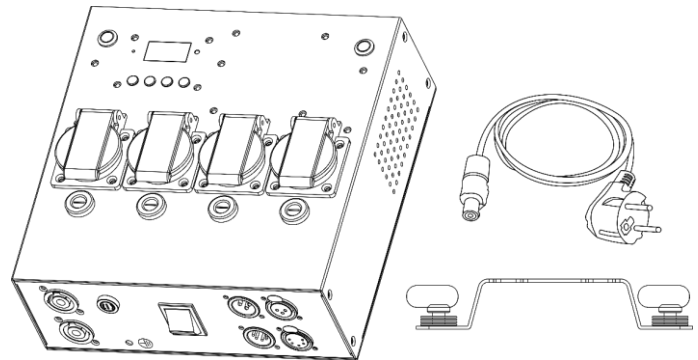

Fig. 01

1.2. Intended Use

This device is intended for professional use as a trailing-edge dimmer. It is suitable only for indoor installation. It is not suitable for households.

Any other use, not mentioned under intended use, is regarded as non-intended and incorrect use.

1.3. Text Conventions

Throughout the user manual the following text conventions are used:

- Buttons: All buttons are in bold lettering, for example "Press the **UP/DOWN** buttons"
- References: References to chapters and parts of the device are in bold lettering, for example: "Refer to **2. Safety**", "turn the **adjustment screw (02)**"
- 0–255: Defines a range of values
- Notes: **Note:** (in bold lettering) is followed by useful information or tips

1.4. Acronyms and Abbreviations

AC	Alternating current	LTP	Latest takes precedence
DMX	Digital multiplex	MOSFET	Metal–oxide–semiconductor field-effect transistor
EMI	Electromagnetic interference	OLED	Organic light-emitting diode
HTP	Highest takes precedence	PID	Parameter Identification
ID	Identification	RDM	Remote Device Management
IEC	International Electrical Committee	SCR	Semiconductor controlled rectifier
IGBT	Insulated-gate bipolar transistor	TRIAC	Triode for alternating current
IP	(<i>technology</i>) Ingress protection	UID	Unique Identification
LED	Light-emitting diode	XLR	External line return

1.5. Symbols and Signal Words

Safety notes and warnings are indicated throughout the user manual by safety signs.

Always follow the instructions provided in this user manual.



DANGER

Indicates an imminently hazardous situation which, if not avoided, will result in death or serious injury.



WARNING

Indicates a potentially hazardous situation which, if not avoided, could result in death or serious injury.



CAUTION

Indicates a potentially hazardous situation, which, if not avoided, may result in minor or moderate injury.



Attention

Indicates important information for the correct operation and use of the product.



Important

Read and observe the instructions in this document.



Electrical hazard



Provides important information about the disposal of this product.

1.6. Symbols on the Information Label

This product is provided with an information label. The information label is located on the backside of the device.

The information label contains the following symbols:



This device shall not be treated as household waste.



This device is designed for indoor use.



Read and follow the instructions in the user manual before installing, operating or servicing the device.



This device falls under IEC protection class I.



Caution: Risk of electric shock. Do not open.
Caution: To reduce the risk of electrical shock, do not remove cover. No user serviceable parts inside. Refer servicing to qualified personnel.

2. Safety



Important

Read and follow the instructions in this user manual before installing, operating or servicing this product.

The manufacturer will not accept liability for any resulting damages caused by the non-observance of this manual.

2.1. Warnings and Safety Instructions



DANGER

Danger for children

For adult use only. The device must be installed beyond the reach of children.

- Do not leave various parts of the packaging (plastic bags, polystyrene foam, nails, etc.) within children's reach. Packaging material is a potential source of danger for children.



DANGER

Electric shock caused by dangerous voltage inside

There are areas within the device where dangerous touch voltage may be present.

- Do not open the device or remove any covers.
- Do not operate the device if the covers or the housing are open. Before operation, check if the housing is firmly closed and all screws are tightly fastened.
- Disconnect the device from electrical power supply before service and maintenance, and when the device is not in use.



DANGER

Electric shock caused by short-circuit

This device falls under IEC protection class I.

- Make sure that the device is electrically connected to ground (earth). Connect the device only to a socket-outlet with ground (earth) connection.
- Do not cover the ground (earth) connection.
- Do not bypass the thermostatic switch or fuses.
- For replacement use fuses of the same type and rating only.
- Do not let the power cable come into contact with other cables. Handle the power cable and all connections with the mains with caution.
- Do not modify, bend, mechanically strain, put pressure on, pull or heat up the power cable.
- Make sure that the power cable is not crimped or damaged. Examine the power cable periodically for any defects.
- Do not immerse the device in water or other liquids. Do not install the device in a location where flooding may occur.
- Do not use the device during thunderstorms. Disconnect the device from the electrical power supply immediately.



Attention
Power supply

- Before connecting the device to the power supply, make sure that the current, voltage and frequency match the input voltage, current and frequency specified on the information label on the device.
- Make sure that the cross-sectional area of the extension cords and power cables is sufficient for the required power consumption of the device.



Attention
General safety

- Do not block the ventilation openings. Without proper heat dissipation and air circulation, the internal components may overheat. This can result in product damage.
- Do not shake the device. Avoid brute force when installing or operating the device.
- If the device is dropped or struck, disconnect the device from the electrical power supply immediately.
- If the device is exposed to extreme temperature variations (e.g. after transportation), do not switch it on immediately. Let the device reach room temperature before switching it on, otherwise it may be damaged by the formed condensation.
- If the device fails to work properly, discontinue the use immediately.



Attention
For professional use only
This device shall be used only for the purposes it is designed for.

This device is designed to be used as a trailing-edge dimmer. Any incorrect use may lead to hazardous situations and result in injuries and material damage.

- This device is not suitable for households.
- This device does not contain user-serviceable parts. Unauthorized modifications to the device will render the warranty void. Such modifications may result in injuries and material damage.



Attention
Before use, examine the device visually for any defects.

Make sure that:

- All screws used for installing the device or parts of the device are tightly fastened and are not corroded.
- There are no deformations on housings, fixations and installation points.
- The power cables are not damaged and do not show any material fatigue.

**Attention****Do not expose the device to conditions that exceed the rated IP class conditions.**

This device is IP20 rated. IP (Ingress Protection) 20 class provides protection against solid objects greater than 12 mm, such as fingers, and no protection against harmful ingress of water.

2.2. Requirements for the User

This product may be used by ordinary persons. Maintenance may be carried by ordinary persons. Installation and service shall be carried out only by instructed or skilled persons. Contact your Highlite dealer for more information.

Instructed persons have been instructed and trained by a skilled person, or are supervised by a skilled person, for specific tasks and work activities associated with the installation, service and maintenance of this product, so that they can identify risks and take precautions to avoid them.

Skilled persons have training or experience, which enables them to recognize risks and to avoid hazards associated with the installation, service and maintenance of this product.

Ordinary persons are all persons other than instructed persons and skilled persons. Ordinary persons include not only users of the product but also any other persons that may have access to the device or who may be in the vicinity of the device.

3. Description of the Device

The TED Pack is a trailing-edge 4-channel dimmer for indoor use. It can be operated in dimmer, switch and FX modes. The device is compatible with LED and incandescent lights of up to 2 A (500 W) per output channel. The TED Pack uses MOSFETs to dim the output and can be switched between leading-edge and trailing-edge dimming. The FX mode offers a safety channel that prevents unintentional activation of the 4 output channels. It can be used for controlling shooters, canons, drops, and similar devices.

3.1. Front View

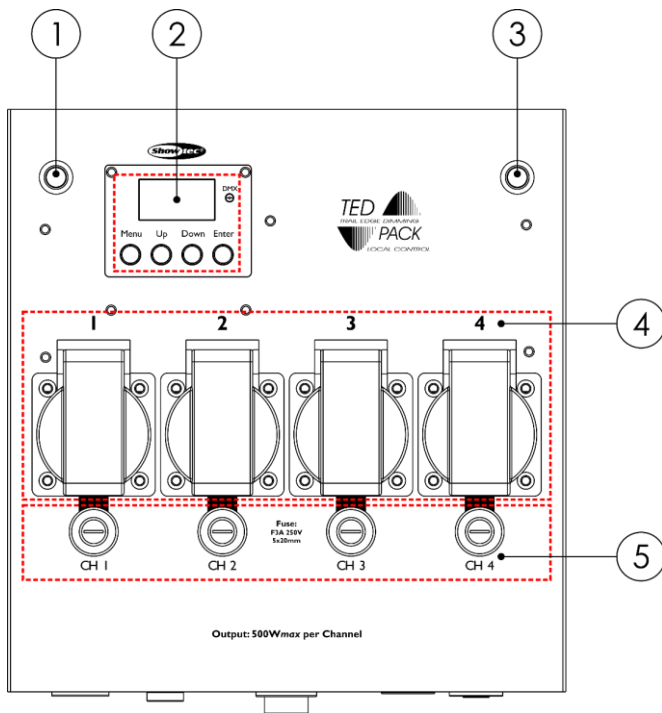

- 01) FX mode LED indicator
- 02) Control panel: OLED display, control buttons, LED indicator
- 03) FX mode LED indicator
- 04) 4 x Schuko sockets (Outputs 1–4)
- 05) 4 x Fuses F3 A, 250 V, 5 x 20 mm (Outputs 1–4)

Fig. 02

3.2. Bottom View

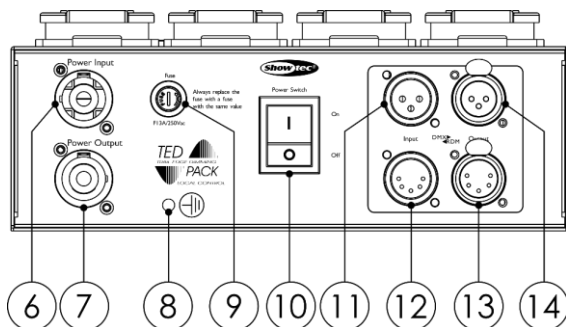

- 06) Pro-power connector IN
- 07) Pro-power connector OUT
- 08) Ground (earth) connection
- 09) Fuse 13 A, 250 V, 6,3 x 30 mm
- 10) Power switch
- 11) 3-pin DMX connector IN
- 12) 5-pin DMX connector IN
- 13) 5-pin DMX connector OUT
- 14) 3-pin DMX connector OUT

Fig. 03

3.3. Back View

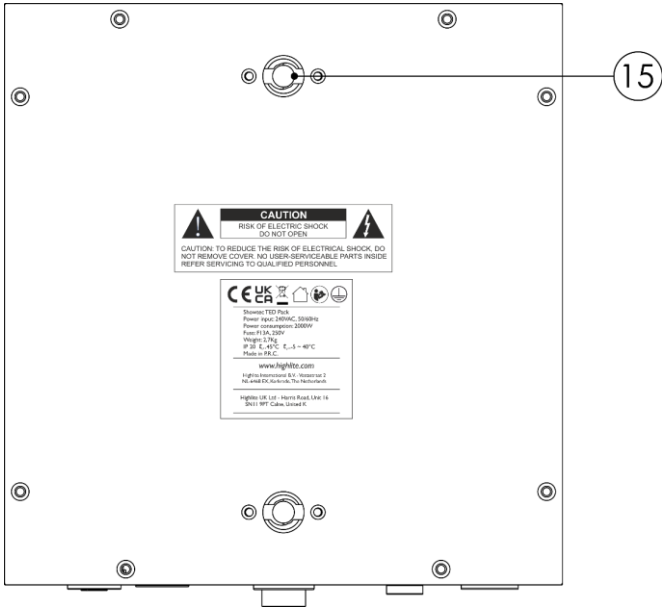

Fig. 04

3.4. Top View

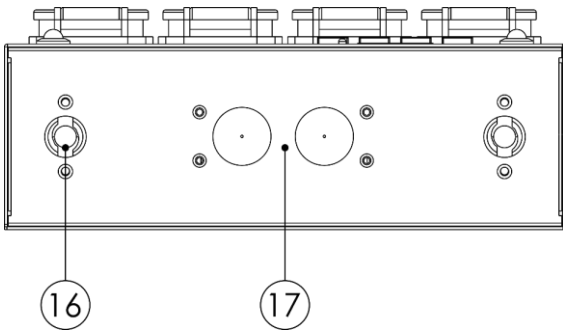

Fig. 05

3.5. Product Specifications

Model:	TED Pack	
Electrical:		
Input voltage:	220–240 V AC, 50 Hz	
Power consumption:	4 W	
Fuse:	4 x F3 A, 250 V, 5 x 20 mm (for each channel) 1 x 13 A, 250 V, 6,3 x 30 mm	
Output wattage (per channel):	500 W max	
Output current (per channel):	2 A	
Physical:		
Dimensions:	240 x 230 x 92 mm (L x W x H)	
Weight:	2,7 kg	
Operation and control:		
Channels:	4 output channels and 1 safety channel	
Control:	Manual, DMX-512, RDM	
DMX personalities:	Dimmer (4 channels), Switch (4 channels), FX (5 channels)	
Control panel:	OLED display, buttons and LED indicators	
Connections:		
Power connections:	Pro-power connectors IN/OUT 4 x Schuko sockets	
Data connections:	3-pin DMX connectors IN/OUT 5-pin DMX connectors IN/OUT	
Signal pinouts:	3-pin: pin 1 (ground), pin 2 (-), pin 3 (+) 5-pin: pin 1 (ground), pin 2 (-), pin 3 (+), pin 4 (N/C), pin 5 (N/C)	
Construction:		
Housing:	Metal	
Color:	Black	
IP rating:	IP20	
Cooling:	Natural heat dissipation	
Thermal:		
Maximum ambient temperature t_a :	40 °C	
Minimum ambient temperature:	-5 °C	

3.6. Dimensions

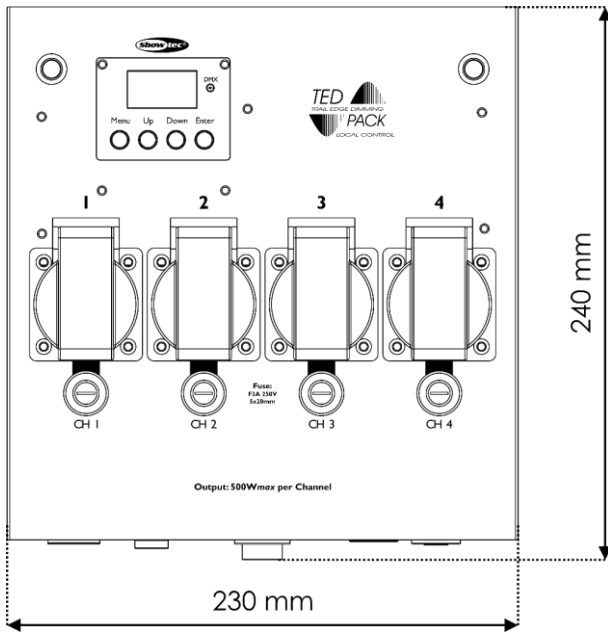

Fig. 06

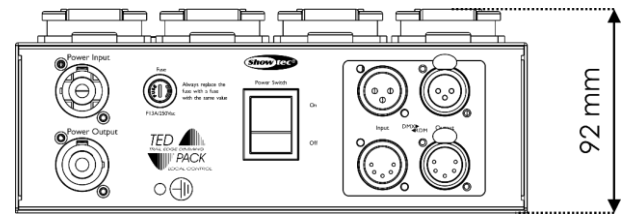

Fig. 07

4. Installation

4.1. Safety Instructions for Installation



WARNING
Incorrect installation can cause serious injuries and damage of property.

If trussing systems are used, installation must be carried out only by instructed or skilled persons.

Follow all applicable European, national and local safety regulations concerning rigging and trussing.

4.2. Personal Protective Equipment

During installation and rigging wear personal protective equipment in compliance with the national and site-specific regulations.

4.3. Installation Site Requirements

- The device can be used only indoors.
- The device can be positioned on a flat surface or mounted to a truss or other rigging structure in any orientation.
- The ambient temperature must be in the range -5 and 40 °C.
- The relative humidity must not exceed 50 % with an ambient temperature of 40 °C.

4.4. Rigging

The device can be positioned on a flat surface or mounted to a truss or other rigging structure in horizontal or vertical orientation. Make sure that all loads are within the pre-determined limits of the supporting structure.



CAUTION

Restrict the access under the work area during rigging and/or derigging.

To mount the device, follow the steps below:

- 01) Fasten the quick lock bracket, supplied with the device, on the **mounting holes for quick lock bracket (15) or (16)**. You can position the quick lock bracket on the top plate of the device or on the back plate of the device, as shown in Fig. 08.
- 02) Install the clamp, as shown in Fig. 09. Make sure that you use a clamp suitable for attaching the device to a truss.

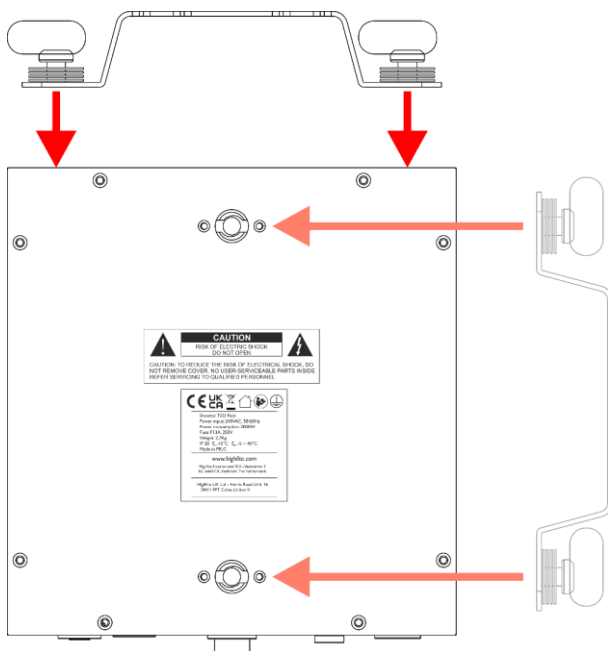

Fig. 08

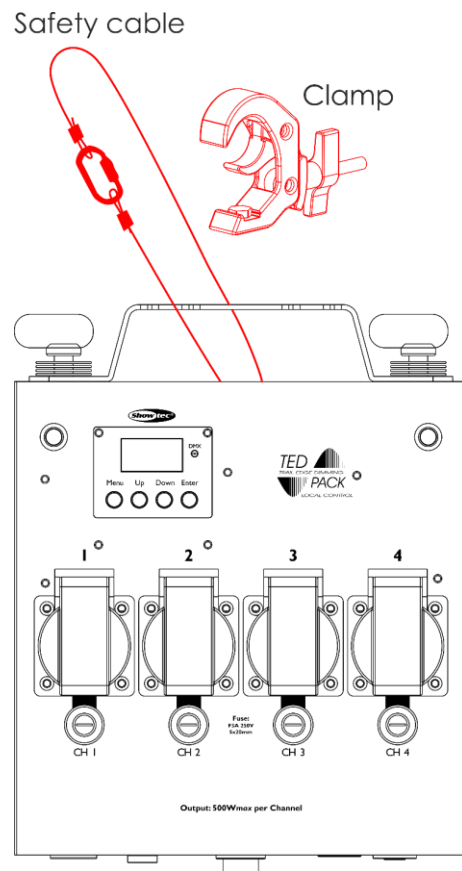

Fig. 09

- 03) Attach the device to the supporting structure. Make sure that the device cannot move freely.
- 04) Secure the device with a secondary suspension, for example a safety cable. Make sure that the secondary suspension can hold 10 times the weight of the device. If possible, the secondary suspension should be attached to a supporting structure independent of the primary suspension. Put the safety cable through the **safety eye (17)**, as shown in Fig. 09.

4.5. Connecting to Power Supply



DANGER
Electric shock caused by short-circuit

The device accepts AC mains power at 220–240 V and 50 Hz. Do not supply power at any other voltage or frequency to the device.

This device falls under IEC protection class I. Make sure that the device is always electrically connected to the ground (earth).

Before connecting the device to the socket-outlet:

- Make sure that the power supply matches the input voltage specified on the information label on the device.
- Make sure that the socket-outlet has ground (earth) connection.

Connect the device to the socket-outlet with the power plug.

4.6. Power Linking of Multiple Devices

This device supports power linking. Power can be relayed to another device via the power OUT connector. Note that the input and the output connectors have different designs: one type cannot be connected to the other.

Power linking of multiple devices must be carried out only by instructed or skilled persons.



WARNING
Incorrect power linking may lead to overload of the electrical circuit and result in serious injuries and damage of property.

To prevent overload of the electrical circuit, when power linking multiple devices:

- Use cables with sufficient current-carrying capacity. The power cable supplied with the device is not suitable for power linking of multiple device.
- Make sure that the total current draw of the device and all connected devices does not exceed the rated capacity of the power cables and the circuit breaker.
- Do not link more devices on one power link than the maximum recommended number.

The maximum recommended number of devices depends on the total load of all connected fixtures and TED Pack devices. The total load shall not exceed 3500 W.

5. Setup

5.1. Warnings and Precautions



Attention

**Connect all data cables before supplying power.
Disconnect power supply before connecting or disconnecting data cables.**

5.2. DMX Connection

5.2.1. DMX-512 Protocol

The TED Pack has 3-pin and 5-pin DMX signal IN and OUT connectors.

The pin assignment is as follows:

- 3-pin: pin 1 (ground), pin 2 (-), pin 3 (+)
- 5-pin: pin 1 (ground), pin 2 (-), pin 3 (+), pin 4 (N/C), pin 5 (N/C)

Devices on a serial data link must be daisy-chained in a single line. The number of devices that you can control on one data link is limited by the combined number of the DMX channels of the connected devices and the 512 channels available in one DMX universe.

To comply with the TIA-485 standard, no more than 32 devices should be connected on one data link. In order to connect more than 32 devices on one data link, you must use a DMX optically isolated splitter/booster, otherwise this may result in deterioration of the DMX signal.

Note:

- Maximum recommended DMX data link distance: 300 m
- Maximum recommended number of devices on a DMX data link: 32 devices

5.2.2. DMX Cables

Shielded twisted-pair cables with 3-pin/5-pin XLR connectors must be used for reliable DMX connection. You can purchase DMX cables directly from your Highlite International dealer or make your own cables.

If you use XLR audio cables for DMX data transmission, this may lead to signal degradation and unreliable operation of the DMX network.

When you make your own DMX cables, make sure that you connect the pins and wires correctly as shown in Fig. 10.

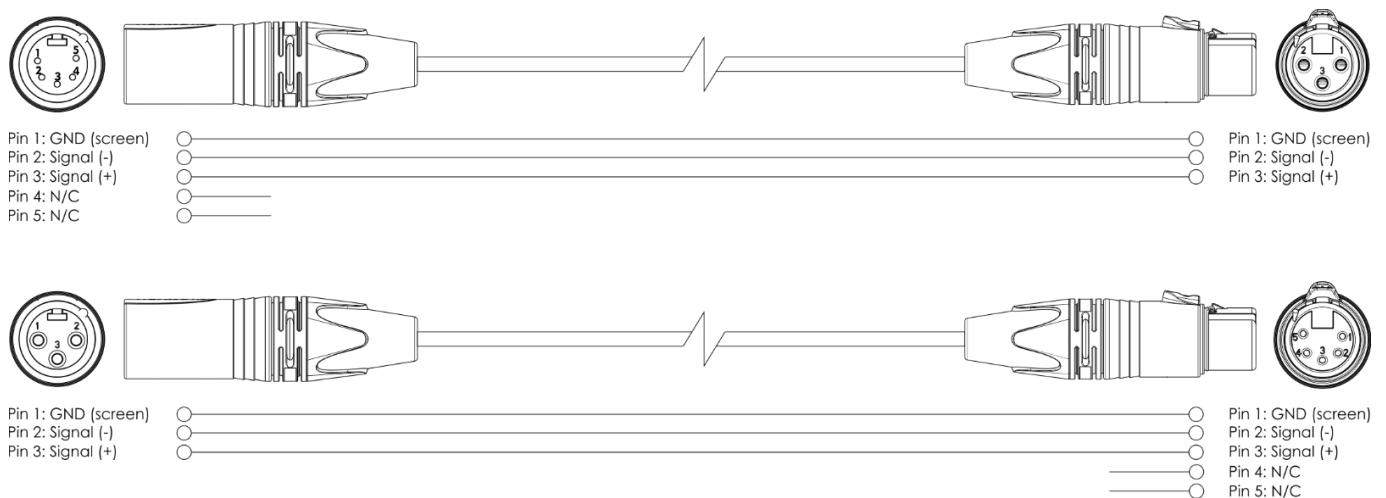

Fig. 10

5.2.3. DMX Linking

To connect multiple devices on one DMX data link, follow the steps below:

- 01) Use a 3-pin/5-pin DMX cable to connect the DMX OUT connector of the lighting controller to the DMX IN connector of the first device. The **DMX LED indicator (A)** on the **control panel (02)** lights up.
- 02) Connect the first device's DMX OUT connector to the second device's DMX IN connector with a 3-pin/5-pin DMX cable.
- 03) Repeat step 2 to connect all devices in a daisy-chain as shown in Fig. 11.
- 04) Connect a DMX terminator (120 Ω resistor) to the DMX OUT connector of the last device on the data link.

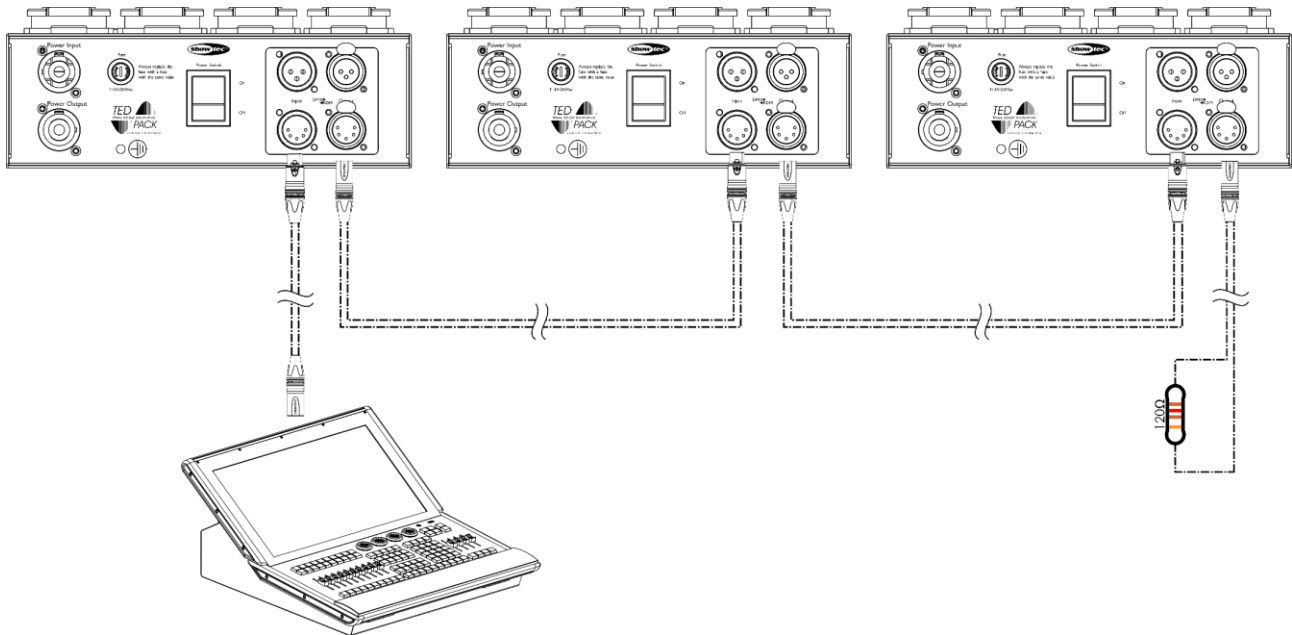

Fig. 11

5.3. Connecting Fixtures

The TED Pack is compatible with both LED and incandescent lighting fixtures. It can be also used for controlling shooters, canons, drops, and similar fixtures.

Make sure that the total load per output does not exceed the maximum wattage (500 W) and the maximum current (2 A).

Connect the fixtures to the **Schuko sockets (04)**.

5.4. Setup Example

Fig. 12 and Fig. 13 show a typical setup with TED Pack used as a trailing-edge dimmer. Make sure that:

- The total load per output does not exceed the maximum wattage (500 W) and current (2 A).
- The total load of all connected fixtures and the device does not exceed 3500 W.

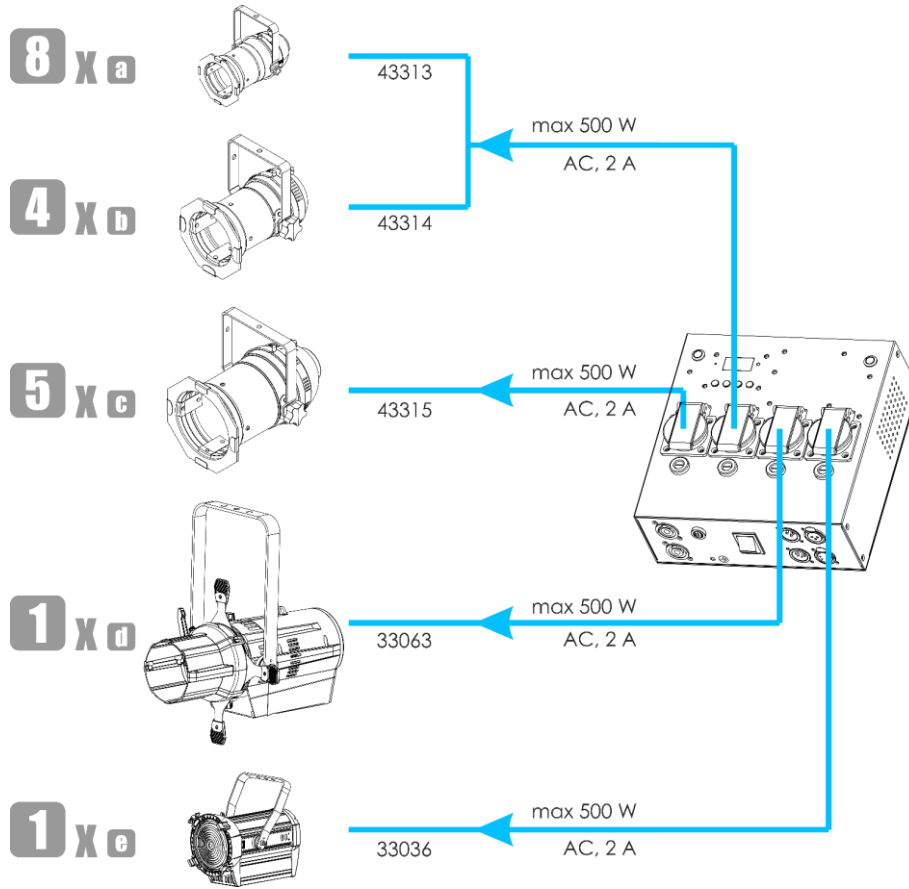

Fig. 12

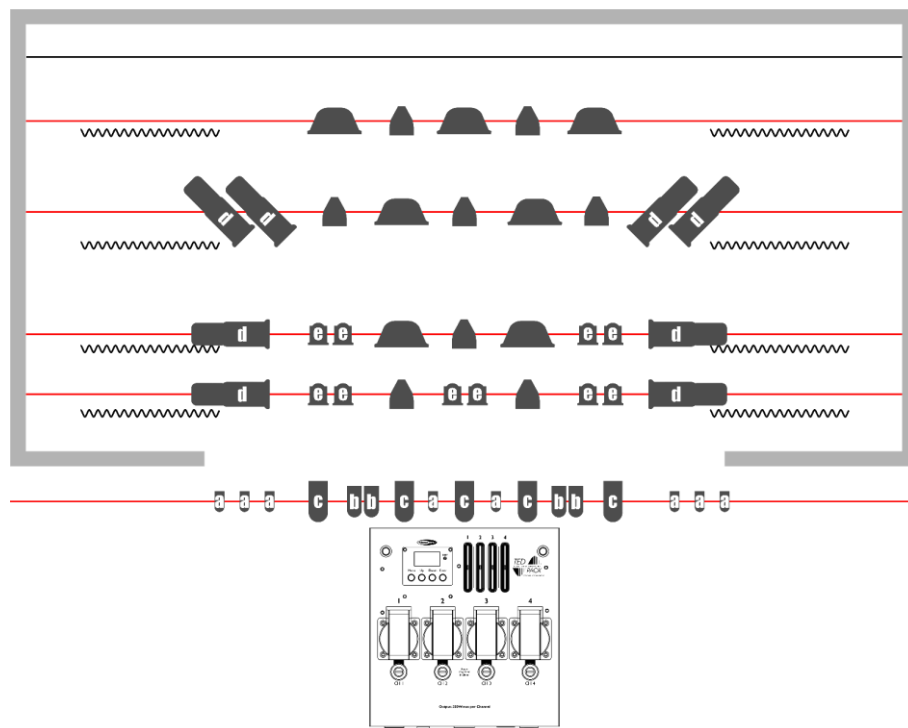

Fig. 13

6. Operation

6.1. Safety Instructions for Operation



Attention

This device must be used only for the purposes it is designed for.

This device is intended for professional use as a trailing-edge dimmer. It is suitable only for indoor installation. It is not suitable for households.

Any other use, not mentioned under intended use, is regarded as non-intended and incorrect use.



Attention

Power supply

Before connecting the device to the power supply, make sure that the current, voltage and frequency match the input voltage, current and frequency specified on the information label on the device.

6.2. Trailing-edge Dimming vs. Leading-edge Dimming

The TED Pack is a trailing-edge dimmer that supports also leading-edge dimming. You can set the dimming mode for each connected fixture separately. See **6.7.5. Dimming Mode** on page 25 for more information.

6.2.1. Trailing-edge Dimming

Trailing-edge dimming is a reverse-phase dimming with a phase-cut at the end of each wave's half cycle before the zero crossing (see Fig. 14). This makes trailing-edge dimming suitable for conductive loads and for lower wattage lamps, for example LED lamps. Trailing-edge dimming does not produce high inrush of current.

Trailing-edge dimmers use MOSFET or IGBT circuits to dim. This technology produces less EMI radiations, current surges and AC distortions. This results in less interference and noise compared to traditional leading-edge dimmers. Trailing-edge dimmers can support also leading-edge dimming.

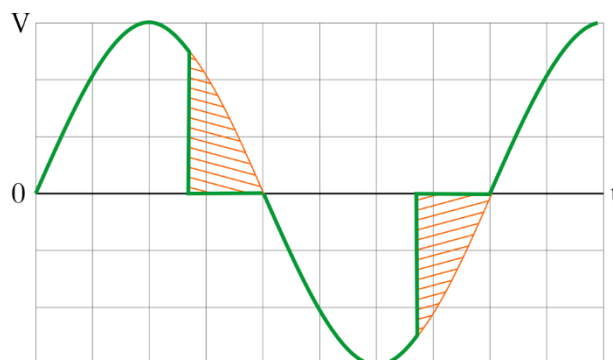

Fig. 14

6.2.2. Leading-edge Dimming

Leading-edge dimming is a forward-phase dimming with a phase-cut at the beginning of each wave's half cycle after the zero crossing (see Fig. 15).

The leading-edge dimmers were originally developed to dim incandescent and halogen lamps. As they have a high minimum load, they are not suitable for low wattage LED lamps.

Traditional leading-edge dimmers use a TRIAC or an SCR to dim. This technology produces more EMI radiations, which results in unwanted interference and buzzing noise. These dimmers do not support trailing-edge dimming.

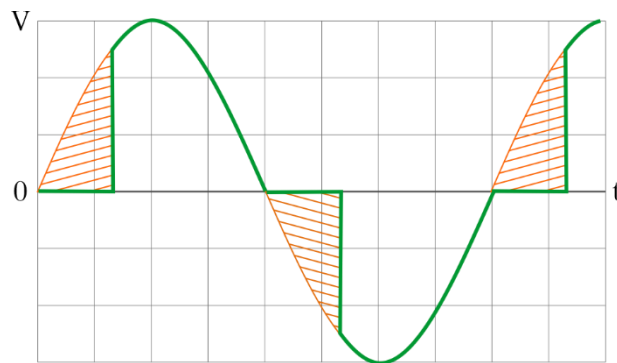

Fig. 15

6.3. Operation Modes

The TED Pack can be operated in dimmer mode, switch mode, FX mode, and auto mode.

6.3.1. Dimmer Mode

In dimmer mode the device functions as a dimmer and you can control the intensity of the light output of the connected fixtures.

The device is compatible with LED and incandescent lights of up to 2 A (500 W) per output channel. Make sure that you select the correct dimming mode. See **6.2. Trailing-edge Dimming vs. Leading-edge Dimming** on pages 18–19 for more information.

You can operate the device in dimmer mode via the **control panel (02)** and via DMX.

6.3.2. Switch Mode

In switch mode you can switch on and off the connected fixtures.

You can operate the device in switch mode via the **control panel (02)** and via DMX.

Note:

In switch mode you cannot adjust the following parameters: minimum output, maximum output, and dimming curve.

6.3.3. FX Mode

In FX mode you can switch on and off the connected fixtures. The FX mode has a safety channel that prevents unintentional switching on/off. This mode can be used for controlling shooters, canons, drops, and similar devices.

You can operate the device in FX mode only via DMX. See **6.8. DMX Channels** on page 29 for more information.

When outputs 1–4 are enabled in FX mode, the **FX mode LED indicators (01)** and **(03)** light up.

Notes:

- In FX mode you cannot adjust the following parameters: minimum output, maximum output, and dimming curve.
- In FX mode the default behaviour of the device in case of a DMX failure is OFF.

6.3.4. Auto Mode

In auto mode you can run one of the 17 built-in chases. You can adjust the speed and the fading time of the built-in chase.

You can operate the device in auto mode only via the **control panel (02)**. See **6.7.10. Chase** on page 27 for more information.

6.4. Control Panel

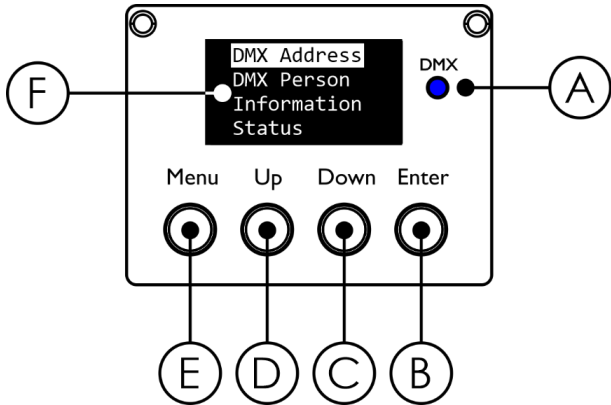

- A) DMX LED indicator
- B) ENTER button
- C) DOWN button
- D) UP button
- E) MENU button
- F) OLED display

Fig. 16

- Use the **MENU** button to exit the current submenu, to return to the main menu and to return to the start screen.
- Use the **UP/DOWN** buttons to navigate through the menus and to select values and options.
- Use the **ENTER** button to open the selected submenu.

6.5. Start-up

The device has a power switch.

- Press the **power switch (10)** in ON position to turn the device on.
- Press the **power switch (10)** in OFF position to turn the device off.

At start-up the display shows a splash screen with the logo of Showtec followed by the start screen.

The start screen provides information about the selected DMX personality and the configuration of the 4 outputs:

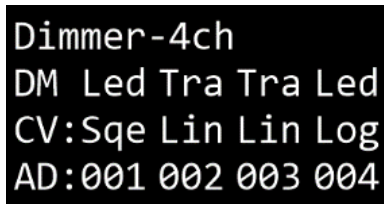

- DMX personality: Dimmer-4ch, Switch-4ch, FX-5ch (operation mode):
- DM (dimming mode): Led (leading-edge), Tra (trailing-edge)
- CV (dimming curve): Lin (linear) Sqe (square), ISq (inverse square), Log (logarithmic)
- AD: DMX starting address of the connected fixture

Press the **MENU** button to toggle between the information screen and the main menu.

Note:

If the display is turned off, press any button to turn the display on. See **6.7.13. Display OFF** on page 28 for more information.

6.6. Menu Overview

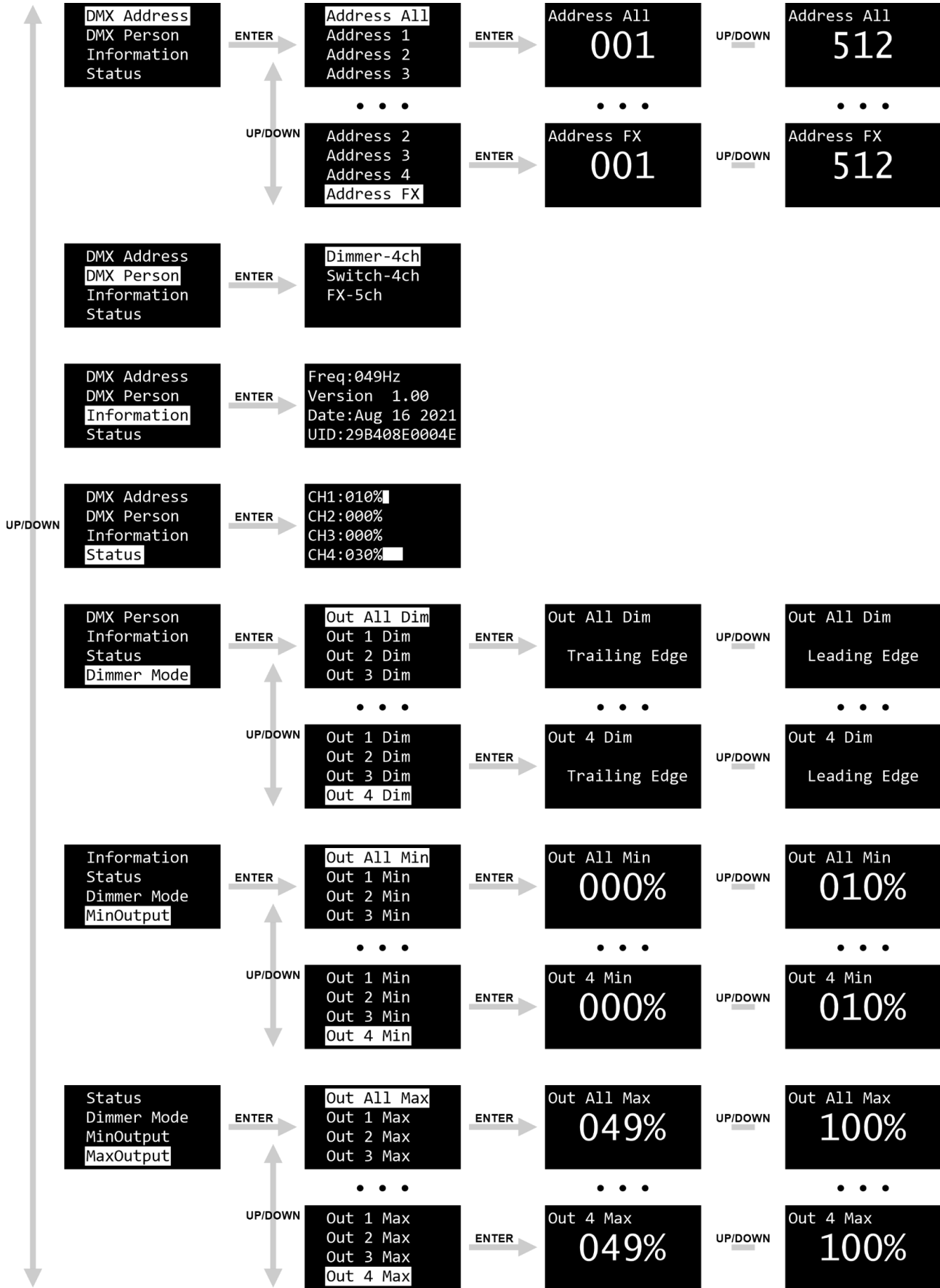

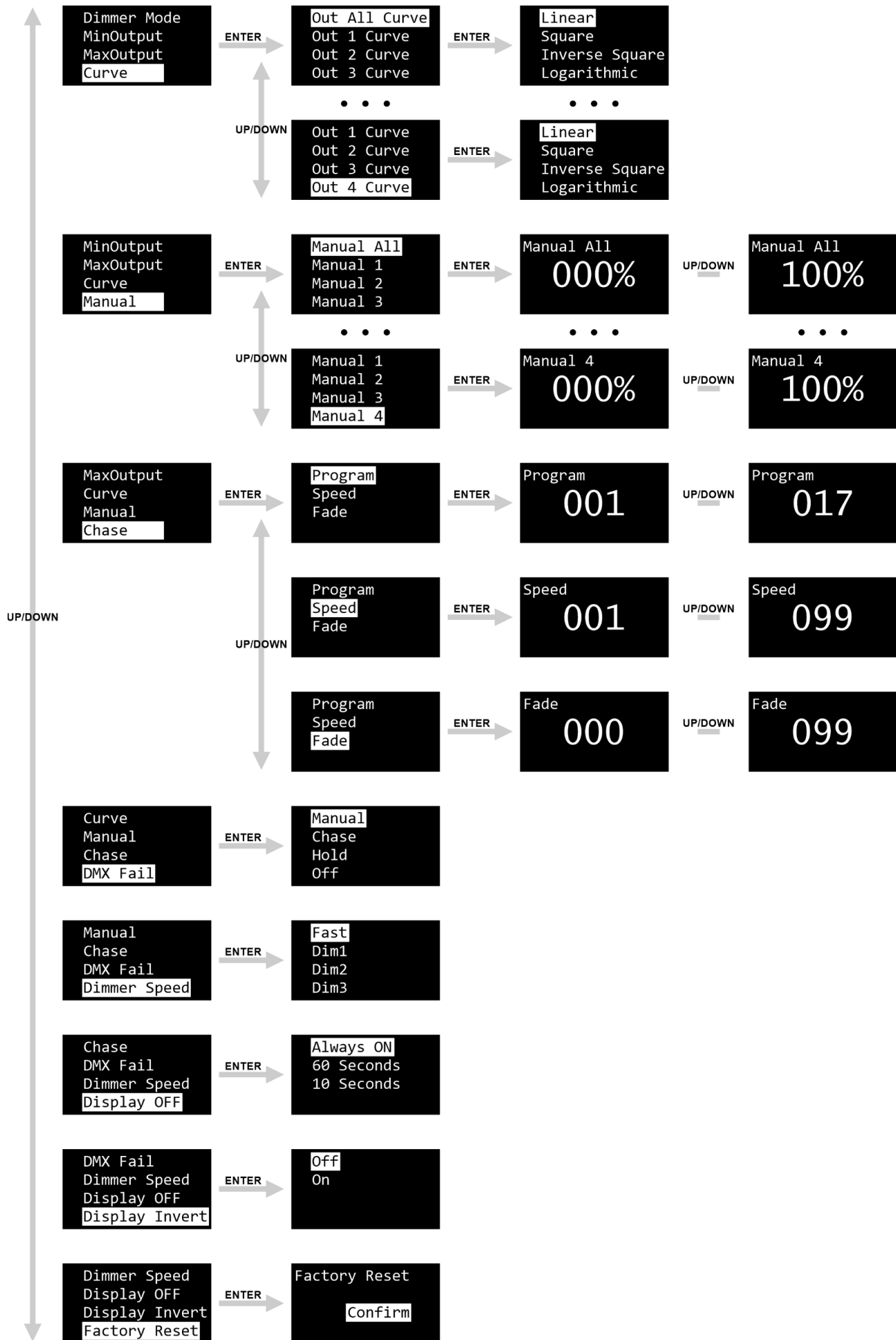

6.7. Main Menu Options

The main menu has the following options:

DMX Address DMX Person Information Status Dimmer Mode MinOutput MaxOutput Curve	DMX Address DMX Person Information Status Dimmer Mode Min Output Max Output Curve	Manual Chase DMX Fail Dimmer Speed Display OFF Display Invert Factory Reset	Manual Chase DMX Fail Dimmer Speed Display OFF Display Invert Factory Reset
--	--	---	---

- 01) Press the **UP/DOWN** buttons to navigate through the main menu.
- 02) Press the **ENTER** button to open the submenus.

6.7.1. DMX Address

In this menu you can set the DMX starting address of the connected fixtures and the FX channel.



- 01) Press the **UP/DOWN** buttons to select one of the channels or all channels together.
- 02) Press the **ENTER** button to confirm the selection and open the submenu.
- 03) Press the **UP/DOWN** buttons to set the DMX starting address:
 - Address All: Select all connected fixtures. The adjustment range is 001–512
 - Address 1: Select the connected fixture(s) on CH1. The adjustment range is 001–512
 - Address 2: Select the connected fixture(s) on CH2. The adjustment range is 001–512
 - Address 3: Select the connected fixture(s) on CH3. The adjustment range is 001–512
 - Address 4: Select the connected fixture(s) on CH4. The adjustment range is 001–512
 - Address FX: Select the FX channel. The adjustment range is 001–512

Note:

If you want to control the connected fixtures on each channel separately, make sure that the DMX starting address of each channel is different.

6.7.2. DMX Person

In this menu you can select the DMX personality (operation mode) for the connected fixtures.

Press the **UP/DOWN** buttons to select the DMX channel mode. There are 3 options available:

- Dimmer-4ch: 4 channels
- Switch-4ch: 4 channels
- FX-5ch: 5 channels

Notes:

- In switch mode and in FX mode you cannot adjust the following parameters: minimum output, maximum output, and dimming curve.
- In FX mode the default behaviour of the device in case of a DMX failure is OFF.

- See **6.8. DMX Channels** on page 29 for more information.
- You cannot adjust the DMX personality (operation mode) for each channel (connected fixture) separately.

6.7.3. Information

In this menu you can view the device's parameters: frequency, firmware version, date of installation of the firmware, and UID.

```
Freq:049Hz
Version 1.00
Date:Aug 16 2021
UID:29B408E0004E
```

6.7.4. Status

In this menu you can view the dimming percentage selected in manual mode. See **6.7.9 Manual** on page 27 for more information.

```
CH1:010%
CH2:000%
CH3:000%
CH4:030%
```

6.7.5. Dimming Mode

In this menu you can set the dimming mode of the connected fixtures.



- 01) Press the **UP/DOWN** buttons to select one of the channels or all channels together.
- 02) Press the **ENTER** button to confirm the selection and open the submenu.
- 03) Press the **UP/DOWN** buttons to select between the following 2 options:
 - **Trailing Edge:** Reverse-phase dimming with a phase-cut at the end of each wave's half cycle (see **6.2.1. Trailing-edge dimming** on page 18 for more information)
 - **Leading Edge:** Forward-phase dimming with a phase-cut at the beginning of each wave's half cycle (see **6.2.2 Leading-edge dimming** on page 19 for more information)

Note:

It is not recommended to use the leading-edge dimming.

6.7.6. Minimum Output

In this menu you can set the minimum light output of the connected fixtures.

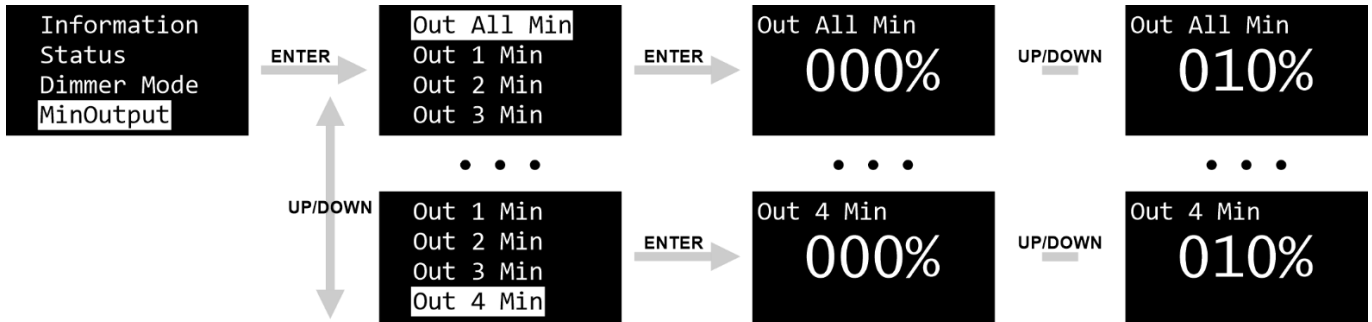

- 01) Press the **UP/DOWN** buttons to select one of the channels or all channels together.
- 02) Press the **ENTER** button to confirm the selection and open the submenu.
- 03) Press the **UP/DOWN** buttons to set the minimum light output. The selection range is 0–10 %.

Note:

In switch mode and in FX mode you cannot set the minimum light output of the connected fixtures.

6.7.7. Maximum Output

In this menu you can set the maximum light output of the connected fixtures.



- 01) Press the **UP/DOWN** buttons to select one of the channels or all channels together.
- 02) Press the **ENTER** button to confirm the selection and open the submenu.
- 03) Press the **UP/DOWN** buttons to set the maximum light output. The selection range is 49–100 %.

Note:

In switch mode and in FX mode you cannot set the maximum light output of the connected fixtures.

6.7.8. Curve

In this menu you can set the dimming curve of the connected fixtures.

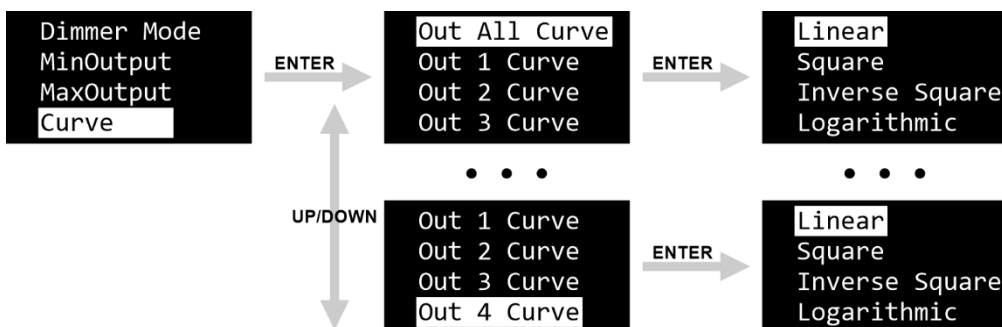

- 01) Press the **UP/DOWN** buttons to select one of the channels or all channels together.
- 02) Press the **ENTER** button to confirm the selection and open the submenu.
- 03) Press the **UP/DOWN** buttons to select one of the following 4 options:
 - Linear
 - Square
 - Inverse Square
 - Logarithmic

Note:

In switch mode and in FX mode you cannot set the dimming curve of the connected fixtures.

6.7.9. Manual

In this menu you can set the intensity of the light output of the connected fixtures.

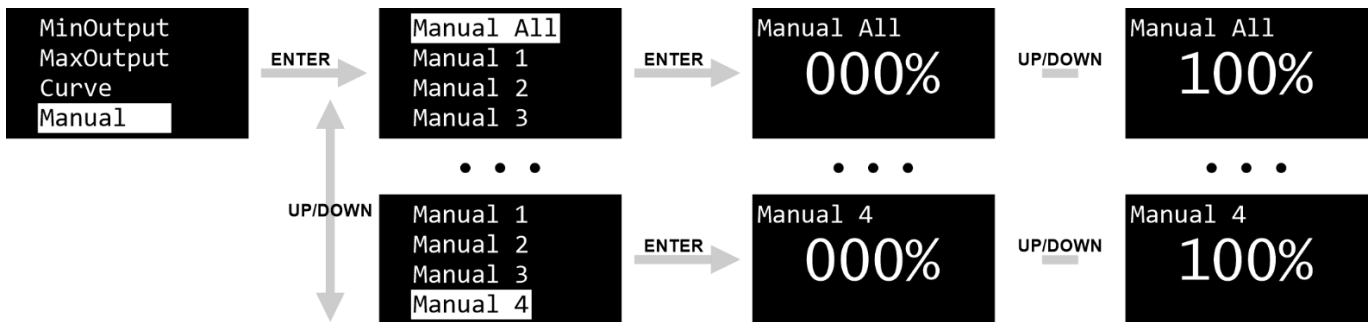

- 01) Press the **UP/DOWN** buttons to select one of the channels or all channels together.
- 02) Press the **ENTER** button to confirm the selection and open the submenu.
- 03) Press the **UP/DOWN** buttons to set the intensity of the light output. The selection range is 0–100 %.

6.7.10. Chase

In this menu you can select one of the 17 built-in chases and adjust the speed and the fading time.

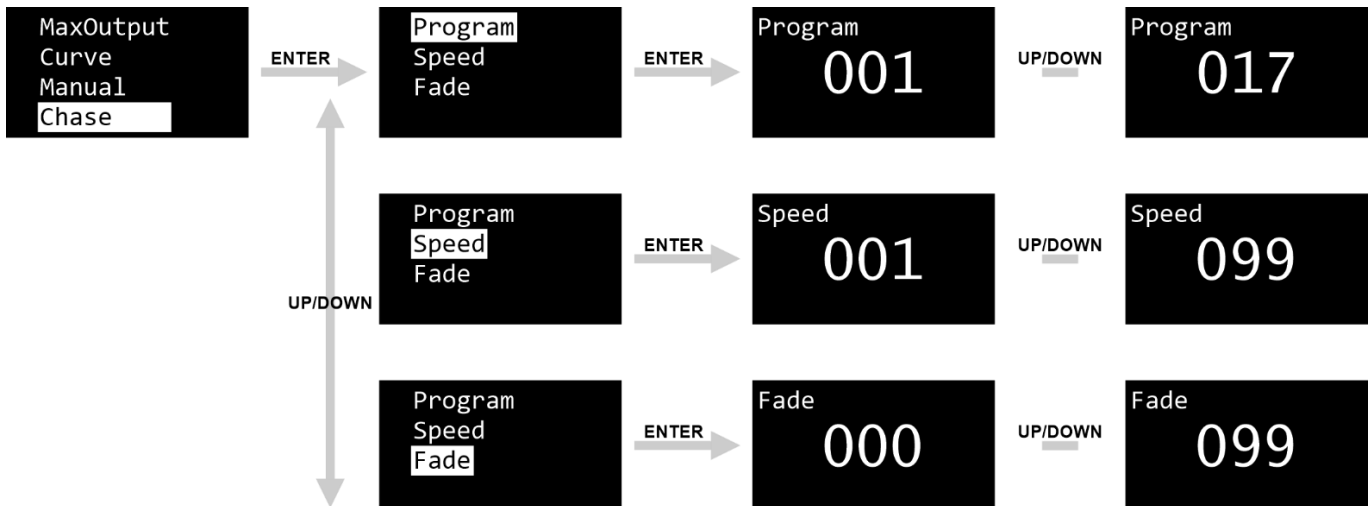

- 01) Press the **UP/DOWN** buttons to select one of the following 3 options:
 - Program: Select one of the 17 built-in chases. The selection range is 1–17
 - Speed: Adjust the speed of the selected chase. The adjustment range is 1–99
 - Fade: Adjust the fading time of the selected chase. The adjustment range is 0–99
- 02) Press the **ENTER** button to confirm the selection and open the submenu.
- 03) Press the **UP/DOWN** buttons to adjust the value.

6.7.11. DMX Fail

In this menu you can set the behavior of the device in case of a DMX failure.

Press the **UP/DOWN** buttons to select one of the following 4 options:

- Manual: The device will use the values selected in manual mode. See **6.7.9. Manual** on page 27 for more information
- Chase: The device will use the chase selected in the chase menu. See **6.7.10. Chase** on page 27 for more information
- Hold: The device will use the last working DMX value on the output
- Off: The device will not output any signal

Note:

In FX mode the default behaviour of the device in case of a DMX failure is OFF.

6.7.12. Dimmer Speed

In this menu you can set the dimmer speed.

Press the **UP/DOWN** buttons to select one of the following 4 options:

- Fast
- Dim1
- Dim2
- Dim3

6.7.13. Display OFF

In this menu you can set the amount of time the backlight on the display stays on after the last button is pressed on the control panel.

Press the **UP/DOWN** buttons to select one of the following 3 options:

- Always ON: The backlight of the display remains on
- 60 seconds: The backlight of the display turns off after 60 seconds of inactivity
- 10 seconds: The backlight of the display turns off after 10 seconds of inactivity

Note:

If the display is turned off, press any button to turn the display on.

6.7.14. Display Invert

In this menu you can set the orientation of the OLED display.

Press the **UP/DOWN** buttons to select one of the following 2 options:

- Off: Normal orientation of the OLED display
- On: The OLED display is rotated at 180°

Note:

If the display is rotated at 180°, the function of the buttons on the control panel will be reversed, as well.

- The **MENU** button will function as **ENTER** button and vice versa.
- The **UP** button will function as **DOWN** button and vice versa.

6.7.15. Factory Reset

In this menu you can restore the default factory settings of the device.

Press the **ENTER** button to confirm the reset of the device. The **FX mode LED indicators (01)** and **(03)** will blink once and the reset will be performed.

6.8. DMX Channels

Dimmer 4 CH	Switch 4 CH	FX 5 CH	Function	Value	Setting
1			Dimmer 1	000-255	Output 1 adjustable (0-100 %)
2			Dimmer 2	000-255	Output 2 adjustable (0-100 %)
3			Dimmer 3	000-255	Output 3 adjustable (0-100 %)
4			Dimmer 4	000-255	Output 4 adjustable (0-100 %)
	1	1	Switch 1	000-127	Output 1 disabled (set to 0 %)
				128-255	Output 1 enabled (set to 100 %)
	2	2	Switch 2	000-127	Output 2 disabled (set to 0 %)
				128-255	Output 2 enabled (set to 100 %)
	3	3	Switch 3	000-127	Output 3 disabled (set to 0 %)
				128-255	Output 3 enabled (set to 100 %)
	4	4	Switch 4	000-127	Output 4 disabled (set to 0 %)
				128-255	Output 4 enabled (set to 100 %)
		5	Safety channel	000-120	Disable control over outputs 1-4 (output remains at 0 %)
				121-131	Enable control over outputs 1-4 (output follows DMX input signal)
				132-255	Disable control over outputs 1-4 (output remains at 0 %)

Notes:

- In switch mode and in FX mode you cannot adjust the following parameters: minimum output, maximum output, and dimming curve.
- In FX mode the default behaviour of the device in case of a DMX failure is OFF.
- When outputs 1-4 are enabled in FX mode, the **FX mode LED indicators (01)** and **(03)** light up.

6.9. RDM Information

This device supports RDM. Refer to **6.9.2. Supported RDM PIDs for the Device** and **6.9.3. Supported RDM PIDs for the SubDevices** for more information.

6.9.1. RDM Details

- Responder ID: 29B4:08EXXXXX
- Manufacturer's ID: Showtec (Highlite International B.V.)
- Manufacturer Label: Showtec
- Model Description: TED Pack
- Model ID: 142 (08E hexadecimal)
- Device Label: TED Pack
- SubDevice 1 Label: TED Pack Out 1
- SubDevice 2 Label: TED Pack Out 2
- SubDevice 3 Label: TED Pack Out 3
- SubDevice 4 Label: TED Pack Out 4

Note:

An RDM responder ID consists of 3 parts:

- 1st part – 4 digits – Manufacturer's ID
- 2nd part – 3 digits – Model ID
- 3rd part – 5 digits – Unique ID

The RDM responder IDs of all products of Highlite International start with the same 4 digits. The first 7 digits of the RDM responder ID for each model are the same. The last 5 digits are different for each device.

6.9.2. Supported RDM PIDs for the Device

Parameter ID	Value	Required	GET	SET
DISC_UNIQUE_BRANCH	0x0001	*		
DISC_MUTE	0x0002	*		
DISC_UN_MUTE	0x0003	*		
SUPPORTED_PARAMETERS	0x0050	*	*	
DEVICE_INFO	0x0060	*	*	
DEVICE_MODEL_DESCRIPTION	0x0080		*	
MANUFACTURER_LABEL	0x0081		*	
DEVICE_LABEL	0x0082		*	*
FACTORY_DEFAULTS	0x0090		*	*
SOFTWARE_VERSION_LABEL	0x00C0	*	*	
BOOT_SOFTWARE_VERSION_ID	0x00C1		*	
BOOT_SOFTWARE_VERSION_LABEL	0x00C2		*	
DMX_PERSONALITY	0x00E0		*	*
DMX_PERSONALITY_DESCRIPTION	0x00E1		*	
DMX_START_ADDRESS	0x00F0	*	*	*
SLOT_INFO	0x0120		*	
SLOT_DESCRIPTION	0x0121		*	
DMX_BLOCK_ADDRESS	0x0140		*	*
DIMMER_INFO	0x0340		*	
MINIMUM_LEVEL	0x0341		*	*
MAXIMUM_LEVEL	0x0342		*	*
CURVE	0x0343		*	*
CURVE_DESCRIPTION	0x0344	*	*	
DISPLAY_INVERT	0x0500		*	*
IDENTIFY_DEVICE	0x1000	*	*	*
RESET_DEVICE	0x1001			*

6.9.3. Supported RDM PIDs for the SubDevices

Parameter ID	Value	Required	GET	SET
SUPPORTED_PARAMETERS	0x0050	*	*	
DEVICE_LABEL	0x0082		*	*
DMX_PERSONALITY	0x00E0		*	*
DMX_PERSONALITY_DESCRIPTION	0x00E1		*	
DIMMER_INFO	0x0340		*	
MINIMUM_LEVEL	0x0341		*	*
MAXIMUM_LEVEL	0x0342		*	*
CURVE	0x0343		*	*

7. Troubleshooting

This troubleshooting guide contains solutions to problems which can be carried out by an ordinary person. The device does not contain user-serviceable parts.

Unauthorized modifications to the device will render the warranty void. Such modifications may result in injuries and material damage.

Refer servicing to instructed or skilled persons. Contact your Highlite International dealer in case the solution is not described in the table.

Problem	Probable cause(s)	Solution
The device does not function at all	No power to the device	<ul style="list-style-type: none"> Check if power is switched on and cables are plugged in
	One of the fuses is blown	<ul style="list-style-type: none"> Replace the fuse. See 8.3.1. Replacing the Fuse on page 33
The device responds erratically	The factory settings of the device are changed	<ul style="list-style-type: none"> Reset the device's parameters to the default factory settings. See 6.7.15. Factory Reset on page 28
The device does not respond to DMX control	The controller is not connected	<ul style="list-style-type: none"> Connect the controller
	The signal is reversed. The 3-pin/5-pin DMX OUT of the controller does not match the DMX IN of the device	<ul style="list-style-type: none"> Install a phase-reversing cable between the controller and the device
	The controller is defective	<ul style="list-style-type: none"> Try using another controller
The device responds erratically to DMX control	Bad data link connection	<ul style="list-style-type: none"> Examine connections and cables. Correct poor connections. Repair or replace damaged cables
	The data link is not terminated with a 120 Ω termination plug	<ul style="list-style-type: none"> Insert a termination plug in the DMX OUT connector of the last device on the link
	Incorrect addressing	<ul style="list-style-type: none"> Check address settings and correct, if necessary
	In case of a setup with multiple devices, one of the devices is defective and disturbs data transmission on the link	<ul style="list-style-type: none"> To find out the defective device, bypass one device at a time until normal operation is restored
The connected fixtures do not function	The fixtures are incompatible	<ul style="list-style-type: none"> Disconnect the fixtures and check their compatibility
	The fixtures are defective	<ul style="list-style-type: none"> Try using different fixtures
	One of the fuses is blown	<ul style="list-style-type: none"> Replace the fuse. See 8.3.1. Replacing the Fuse on page 33

8. Maintenance

8.1. Safety Instructions for Maintenance



DANGER
Electric shock caused by dangerous voltage inside

Disconnect power supply before servicing or cleaning.

8.2. Preventive Maintenance



Attention
Before use, examine the device visually for any defects.

Make sure that:

- All screws used for installing the device or parts of the device are tightly fastened and are not corroded.
- The safety devices are not damaged.
- There are no deformations on housings, fixations and installation points.
- The power cables are not damaged and do not show any material fatigue.

8.2.1. Basic Cleaning Instructions

To clean the device, follow the steps below:

- 01) Disconnect the device from the electrical power supply.
- 02) Allow the device to cool down for at least 5 minutes.
- 03) Clean the device with a soft, lint-free cloth.



Attention

- Do not immerse the device in liquid.
- Do not use alcohol or solvents.

8.3. Corrective Maintenance

The device does not contain user-serviceable parts. Do not open the device and do not modify the device.

Refer repairs and servicing to instructed or skilled persons. Contact your Highlite International dealer for more information.

8.3.1. Replacing the Fuse



DANGER
Electric shock caused by short-circuit

- Do not bypass the thermostatic switch or fuses.
- For replacement use fuses of the same type and rating only.

Power surges, short-circuit or incorrect electrical power supply may cause a fuse to burn out. If the fuse burns out, the device will not function anymore. If this happens, follow the steps below.

- 01) Disconnect the device from the electrical power supply.
- 02) Allow the device to cool down for at least 5 minutes.
- 03) Loosen the fuse cover with a screwdriver and remove the fuse holder.
- 04) If the fuse is brown or unclear, it is burned out. Remove the old fuse.
- 05) Insert a new fuse in the fuse holder. Make sure that the type and the rating of the replacement fuse are the same as the ones specified on the information label of the product.
- 06) Replace the fuse holder in the opening and tighten the fuse cover.

9. Deinstallation, Transportation and Storage

9.1. Instructions for Deinstallation



WARNING

Incorrect deinstallation can cause serious injuries and damage of property.

- Let the device cool down before dismounting.
- Disconnect power supply before deinstallation.
- Always observe the national and site-specific regulations during deinstallation and derigging of the device.
- Wear personal protective equipment in compliance with the national and site-specific regulations.

9.2. Instructions for Transportation

- Use the original packaging to transport the device, if possible.
- Always observe the handling instructions printed on the outer carton box, for example: "Handle with care", "This side up", "Fragile".

9.3. Storage

- Clean the device before storing. Follow the cleaning instructions in chapter **8.2.1. Basic Cleaning Instructions** on page 32.
- Store the device in the original packaging, if possible.

10. Disposal

Correct disposal of this product



Waste Electrical and Electronic Equipment

This symbol on the product, its packaging or documents indicates that the product shall not be treated as household waste. Dispose of this product by handing it to the respective collection point for recycling of electrical and electronic equipment. This is to avoid environmental damage or personal injury due to uncontrolled waste disposal. For more detailed information about recycling of this product contact the local authorities or the authorized dealer.

11. Approval



Check the respective product page on the website of Highlite International (www.highlite.com) for an available declaration of conformity.



©2022 Showtec