

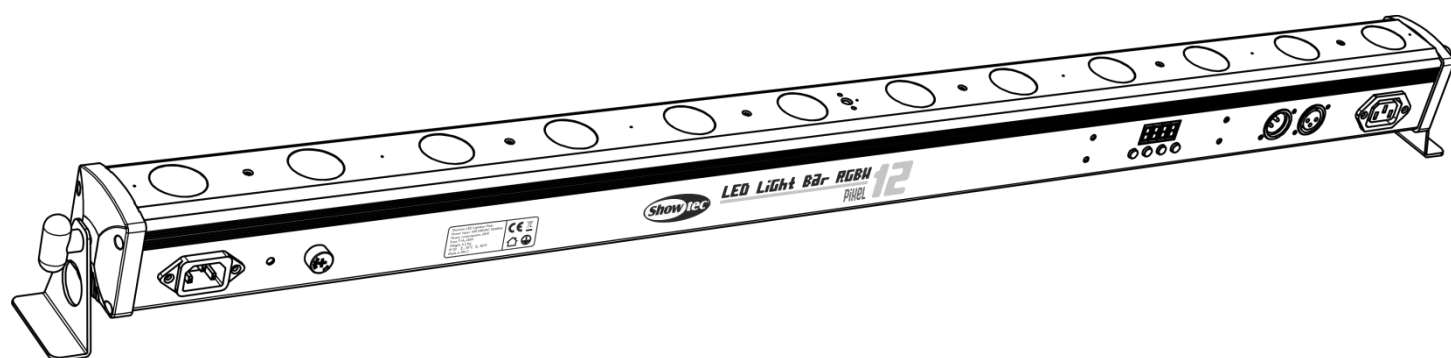

MANUAL



ENGLISH

LED Lightbar 12 Pixel

V2

Ordercode: 42197

Table of contents

Warning 2

 Safety Instructions 2

 Operating Determinations 4

 Rigging 4

 Connection with the mains 5

 Return Procedure 5

 Claims 5

Description of the device 6

 Optional accessories 6

 Overview 7

Installation 7

Set Up and Operation 7

 Control Modes 7

 One LED Lightbar 12 Pixel (Built-in programs, Auto Run) 7

 One LED Lightbar 12 Pixel (Sound-control) 7

 One LED Lightbar 12 Pixel (Manual control) 8

 Multiple LED Lightbars 12 Pixel (Master/Slave control) 8

 Multiple LED Lightbars 12 Pixel (DMX512 Mode) 9

 Fixture Linking 10

 Data Cabling 10

 Control Panel 11

 DMX Control Mode 11

 DMX Addressing 11

Menu overview 12

 Main Menu Options 13

 Built-in Programs 13

 Auto Run Program 14

 DMX Mode 14

 Master / slave addressing 15

 Sound control Mode 15

 Static Color Mode 16

 Settings 16

 Reset factory settings 16

 DMX Channels 17

 4 DMX Channels 17

 4 DMX Channels 17

 6 DMX Channels 18

 12 DMX Channels 18

 10 DMX Channels 20

 18 DMX Channels 21

 48 DMX Channels 24

Maintenance 26

 Replacing a Fuse 26

Troubleshooting 26

 No Light 26

 No Response to DMX 26

Product Specifications 28

Dimensions 29

Notes 30

Warning



**For your own safety, please read this user manual carefully
before your initial start-up!**



Unpacking Instructions

Immediately upon receiving this product, carefully unpack the carton and check the contents to ensure that all parts are present, and have been received in good condition. Notify the dealer immediately and retain packing material for inspection if any parts appear to be damaged from shipping or the carton itself shows signs of mishandling. Save the carton and all packing materials. In the event that the fixture must be returned to the factory, it is important that the fixture be returned in the original factory box and packing.

Your shipment includes:

- Showtec LED Lightbar 12 Pixel
- 2 brackets and screws
- IEC powercable 1,5m
- User manual

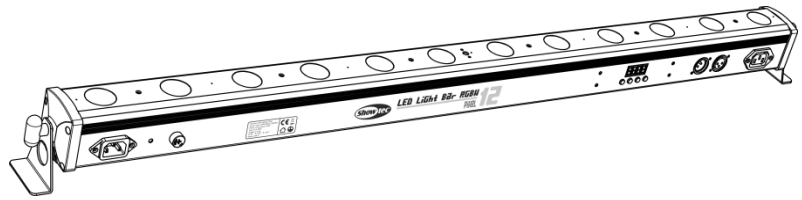

LED Expected Lifespan

LEDs gradually decline in brightness over time. HEAT is the dominant factor that leads to the acceleration of this decline. Packaged in clusters, LEDs exhibit higher operating temperatures than in ideal or singular optimum conditions. For this reason when all color LEDs are used at their fullest intensity, life of the LEDs is significantly reduced. If improving the lifespan is of higher priority, place care in providing for lower operational temperatures. This may include climatic-environmental and the reduction of overall projection intensity.



CAUTION!

**Keep this device away from rain and moisture!
Unplug mains lead before opening the housing!**



Safety Instructions

Every person involved with the installation, operation and maintenance of this device has to:

- be qualified
- follow the instructions of this manual



**CAUTION! Be careful with your operations.
With a dangerous voltage you can suffer
a dangerous electric shock when touching the wires!**



Before your initial start-up, please make sure that there is no damage caused by transportation. Should there be any, consult your dealer and do not use the device.

To maintain perfect condition and to ensure a safe operation, it is absolutely necessary for the user to follow the safety instructions and warning notes written in this manual.

Please consider that damages caused by manual modifications to the device are not subject to warranty. This device contains no user-serviceable parts. Refer servicing to qualified technicians only.

IMPORTANT:

The manufacturer will not accept liability for any resulting damages caused by the non-observance of this manual or any unauthorized modification to the device.

- Never let the power cord come into contact with other cables! Handle the power cord and all connections with the mains with particular caution!
- Never remove warning or informative labels from the unit.
- Never use anything to cover the ground contact.
- Never place any material over the lens.
- Never look directly into the light source.
- Never leave any cables lying around.
- Do not insert objects into air vents.
- Do not connect this device to a dimmerpack.
- Do not switch the device on and off in short intervals, as this would reduce the device's lifespan.
- Do not touch the device's housing bare-handed during its operation. Allow the fixture to cool for at least 5 minutes before handling.
- Do not shake the device. Avoid brute force when installing or operating the device.
- Only use device indoor, avoid contact with water or other liquids.
- Only operate the fixture after having checked that the housing is firmly closed and all screws are tightly fastened.
- Only operate the device after having familiarized with its functions.
- Avoid flames and do not put close to flammable liquids or gases.
- Always keep case closed while operating.
- Always allow free air space of at least 50 cm around the unit for ventilation.
- Always disconnect power from the mains, when device is not used or before cleaning! Only handle the power cord by the plug. Never pull out the plug by tugging the power cord.
- Make sure that the device is not exposed to extreme heat, moisture or dust.
- Make sure that the available voltage is not higher than stated on the rear panel.
- Make sure that the power cord is never crimped or damaged. Check the device and the power cord from time to time.
- If the lens is obviously damaged, it has to be replaced to prevent its functions from being impaired, due to cracks or deep scratches.
- If device was dropped or struck, disconnect mains power supply immediately. Have a qualified engineer inspect for safety before operating.
- If the device has been exposed to drastic temperature fluctuation (e.g. after transportation), do not switch it on immediately. The arising condensation water might damage your device. Leave the device switched off until it has reached room temperature.
- If your Showtec device fails to work properly, discontinue use immediately. Pack the unit securely (preferably in the original packing material), and return it to your Showtec dealer for service.
- For adult use only. Device must be installed out of reach of children. Never leave the unit running unattended.
- Never attempt to bypass the thermostatic switch or fuses.
- For replacement, use fuses of same type and rating only.
- The user is responsible for correct positioning and operating of the LED Lightbar 12 Pixel. The manufacturer will not accept liability for damages caused by the misuse or incorrect installation of this device.
- This device falls under protection class I. Therefore it is essential to connect the yellow/green conductor to earth.
- During the initial start-up, some smoke or smell may arise. This is a normal process and does not necessarily mean that the device is defective.
- Repairs, servicing and electrical connection must be carried out by a qualified technician.
- WARRANTY: Till one year after date of purchase.



CAUTION! Eyedamages!!!
Avoid looking directly into the lightsource!!!
(meant especially for epileptics)!!!



Operating Determinations

- This device is not designed for permanent operation. Regular operation breaks will ensure that the device will serve you for a long time without defects.
- The minimum distance between light-output and the illuminated surface must be bigger than 1 meter.
- The maximum ambient temperature $t_a = 40^{\circ}\text{C}$ must never be exceeded.
- The relative humidity must not exceed 50 % with an ambient temperature of 40°C .
- If this device is operated in any other way than the one described in this manual, the product may suffer damages and the warranty becomes void.
- Any other operation may lead to dangers like short-circuit, burns, electric shock, crash etc.

You endanger your own safety and the safety of others!

Rigging

Please follow the European and national guidelines concerning rigging, trussing and all other safety issues.

Do not attempt the installation yourself!

Always let the installation be carried out by an authorized dealer!

Procedure:

- If the LED Lightbar 12 Pixel is lowered from the ceiling or high joists, professional trussing systems have to be used.
- Use a clamp to mount the LED Lightbar 12 Pixel, with the mounting-bracket, to the trussing system.
- The LED Lightbar 12 Pixel must never be fixed swinging freely in the room.
- The installation must always be secured with a safety attachment, e.g. an appropriate safety net or safety-cable.
- When rigging, derigging or servicing the LED Lightbar 12 Pixel, always make sure, that the area below the installation place is blocked and staying in the area is forbidden.

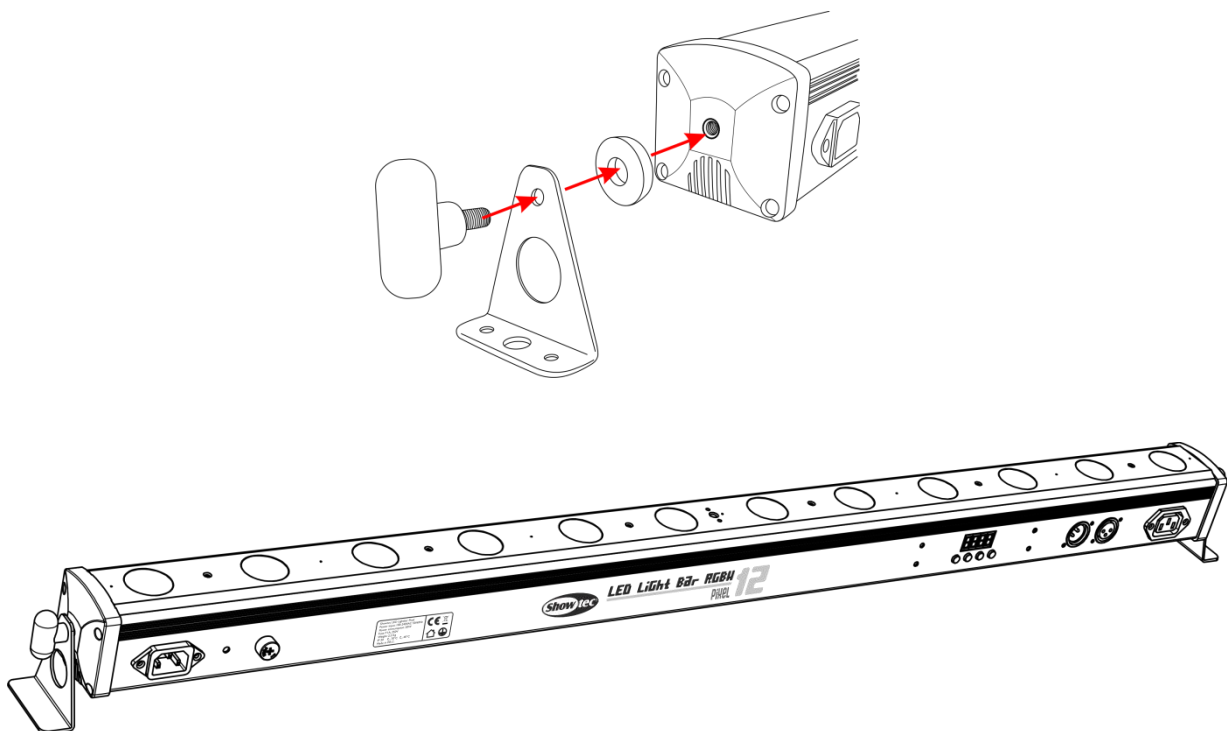

The LED Lightbar 12 Pixel can be placed on a flat stage floor or mounted to any kind of truss by a clamp.

Connection with the mains

Connect the device to the mains with the power plug.
Always check if the right color cable is connected to the right place.

International	EU Cable	UK Cable	US Cable	Pin
L	BROWN	RED	YELLOW/COPPER	PHASE
N	BLUE	BLACK	SILVER	NEUTRAL
	YELLOW/GREEN	GREEN	GREEN	PROTECTIVE GROUND

Make sure that the device is always connected properly to the earth!

Improper installation can cause serious damage to people and property!

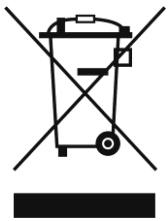

Return Procedure



Returned merchandise must be sent prepaid and in the original packing, call tags will not be issued. Package must be clearly labeled with a Return Authorization Number (RMA number). Products returned without an RMA number will be refused. Highlite will not accept the returned goods or any responsibility. Call Highlite 0031-455667723 or mail aftersales@highlite.nl and request an RMA prior to shipping the fixture. Be prepared to provide the model number, serial number and a brief description of the cause of the return. Be sure to properly pack fixture as any shipping damage resulting from inadequate packaging is the customer's responsibility. Highlite reserves the right to use its own discretion to repair or replace product(s). As a suggestion, proper UPS packing or double-boxing is always a safe method to use.

Note: If you are given an RMA number, please include the following information on a piece of paper inside the box:

- 01) Your name.
- 02) Your address.
- 03) Your phone number.
- 04) A brief description of the symptoms.

Claims

The client has the obligation to check the delivered goods immediately upon delivery for any shortcomings and/or visible defects, or perform this check after our announcement that the goods are at their disposal. Damage incurred in shipping is the responsibility of the shipper; therefore the damage must be reported to the carrier upon receipt of merchandise.

It is the customer's responsibility to notify and submit claims with the shipper in the event that the fixture is damaged due to shipping. Transportation damage has to be reported to us within one day after receipt of the delivery.

Any return shipment has to be made post-paid at all times. Return shipments must be accompanied with a letter defining the reason for return shipment. Non-prepaid return shipments will be refused, unless agreed otherwise in writing.

Complaints against us must be made known in writing or by fax within 10 working days after receipt of the invoice. After this period, complaints will not be handled anymore.

Complaints will only be considered if the client has so far complied with all parts of the agreement, regardless of the agreement of which the obligation is resulting.

Description of the device

Features

The Showtec LED Lightbar 12 Pixel is a cost effective LED bar with 12 x 4-in-1 RGBW LEDs. It offers full pixel control in 48 channel mode to create beautiful color flows but can also be controlled in 4, 6, 10, 12 or 18 channel mode. With the RGBW LEDs it is possible to create both saturated and pastel colors.

- LEDs: 12 x 2W RGBW
- Beam angle: 30 °
- Compact size
- Pixel control
- Power and data daisy chain
- Lumen @2m: 500 (Full On)
- Colormixing: RGBW
- Power Supply: 100-240V AC, 50/60Hz
- Drive current: 100 mA
- Refresh rate: 2 KHz
- Control Mode: DMX512
- Dimmer: 0-100%
- Strobe: 0-20Hz
- Power Consumption: 20 Watt
- 3 pin female XLR socket and 3 pin male XLR socket
- IEC Power In and IEC power Out (Max. 10A)
- Linkable via 3-pin XLR cable
- Built-in microphone
- Housing: aluminum
- LED display
- Fuse: T1L / 250V
- Cooling: aluminum heatsink
- IP rating: IP-20
- Built-in programs mode, Auto running mode, DMX mode, slave mode, static color mode and sound-activated mode.
- Selectable 4, 4, 6, 10, 12, 18 and 48 DMX channel operation
- Dimensions: 1080 x 65 x 88 mm (LXWXH) (incl. brackets)
- Weight: 2,14 kg

Note: Knowledge of DMX is required to fully utilize this unit.

Optional accessories

[D7012](#) Case for 4x LED Bar Value Line

[D7595](#) LED Bar Case

Overview

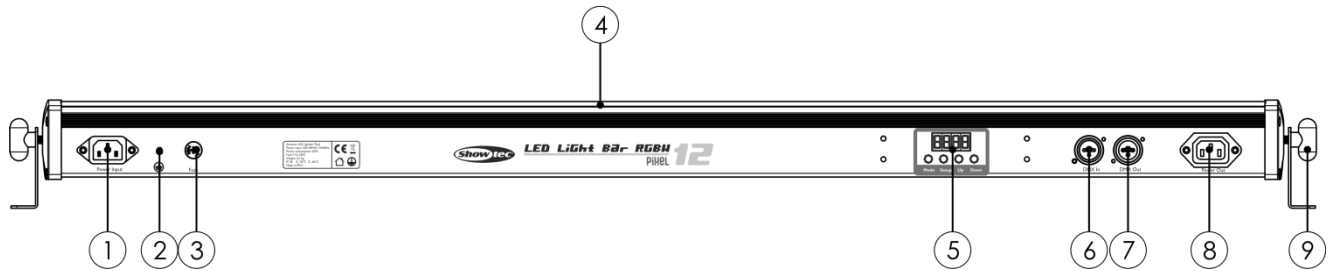

Fig. 01

- 01) IEC Power In
- 02) Ground/Earth connection
- 03) Fuse T1L / 250V
- 04) 12 x 2W RGBW
- 05) Menu Buttons + LED display
- 06) DMX signal connector (IN) 3-pin
- 07) DMX signal connector (OUT) 3-pin
- 08) IEC Power Out (max 10A)
- 09) Adjustment screw + mounting bracket for Truss mounting

Installation

Remove all packing materials from the LED Lightbar 12 Pixel.

Check that all foam and plastic padding is removed. Connect all cables.

Do not supply power before the whole system is set up and connected properly.

Always disconnect from electric mains power supply before cleaning or servicing.

Damages caused by non-observance are not subject to warranty.

Set Up and Operation

Follow the directions below, as they pertain to your preferred operation mode.

Before plugging the unit in, always make sure that the power supply matches the product specification voltage. Do not attempt to operate a 120V specification product on 230V power, or vice versa.

Connect the device to the main power supply.

Control Modes

- There are 6 modes:
- Built-in Programs
 - Auto Run
 - Sound-controlled
 - Manual control (Static)
 - Master/Slave
 - DMX512

One LED Lightbar 12 Pixel (Built-in programs, Auto Run)

- 01) Fasten the effect light onto firm trussing or place it on the floor. Leave at least 0,5 meter on all sides for air circulation.
- 02) When the LED Lightbar is not connected by a DMX-cable, it functions as a stand-alone device.
- 03) If device is set to **P-01** or **AUTO**, then the fixture will play one of its built-in programs or show its auto run mode. Please see pages 13-14 for more information about the built-in programs or auto run mode.

One LED Lightbar 12 Pixel (Sound-control)

- 01) Fasten the effect light onto firm trussing or place it on the floor. Leave at least 0,5 meter on all sides for air circulation.
- 02) When the LED Lightbar is not connected by a DMX-cable, it functions as a stand-alone device.
- 03) Turn on the music. If device is set to **Sound** (Audio), then the fixture will react to the beat of the music. Please see page 15 for more information about the Sound-controlled mode.

One LED Lightbar 12 Pixel (Manual control)

- 01) Fasten the effect light onto firm trussing or place it on the floor. Leave at least 0,5 meter on all sides for air circulation.
- 02) When the LED Lightbar is not connected by a DMX-cable, it functions as a stand-alone device.
- 03) If device is set to **Color**, then the fixture can be manually controlled.
- 04) Please see page 16 for more information about the Manual control mode.

Multiple LED Lightbars 12 Pixel (Master/Slave control)

- 01) Fasten the effect light onto firm trussing or place it on the floor. Leave at least 0,5 meter on all sides for air circulation.
- 02) Plug the end of the electric mains power cord into a proper electric power supply socket.
- 03) Use a 3-p XLR cable to connect the LED Lightbars and other devices.

The pins:



1. Earth
2. Signal (-)
3. Signal (+)

- 04) Link the units as shown in Fig. 02, connect a DMX signal cable from the first unit's DMX "out" socket to the second unit's "in" socket. Repeat this process to link the second and third units. You can use the same functions on the master device as described on pages 13-14 (Built-in Programs, Auto run). This means you can set your desired operation mode on the master device and all slave devices will react the same as the master device.

Multiple LED Lightbars 12 Pixel (Master/Slave control)

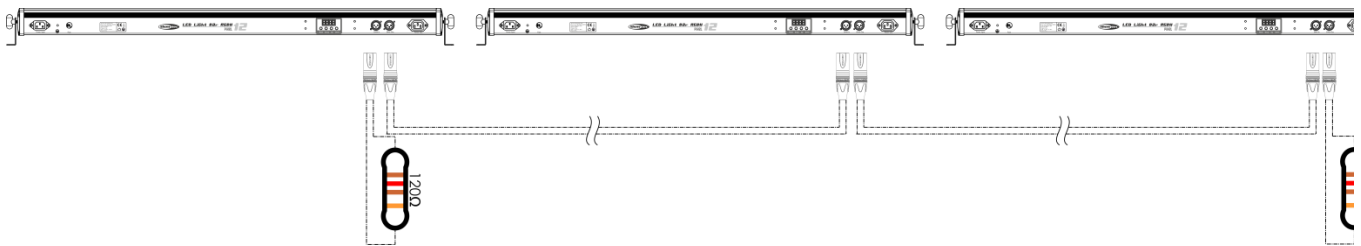
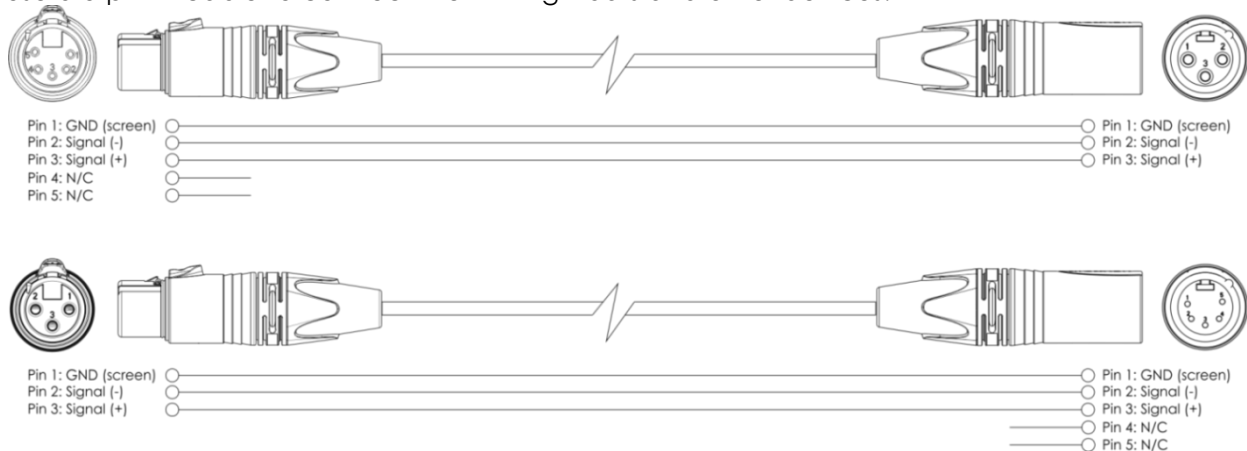

Fig. 02

Multiple LED Lightbars 12 Pixel (DMX512 Mode)

- 01) Fasten the effect light onto firm trussing or place it on the floor. Leave at least 0,5 meter on all sides for air circulation.
- 02) Plug the end of the electric mains power cord into a proper electric power supply socket.
- 03) Use a 3-p XLR cable to connect the LED Lightbars and other devices.



- 04) Link the units as shown in Fig. 03, Connect a DMX signal cable from the first unit's DMX "out" socket to the second unit's "in" socket. Repeat this process to link the second and third units.
- 05) Supply electric power: Plug electric mains power cords into each unit's IEC socket, then plug the other end of the mains power cord into proper electric power supply sockets, starting with the first unit. Do not supply power before the whole system is set up and connected properly.

Multiple LED Lightbars 12 Pixel DMX Set Up

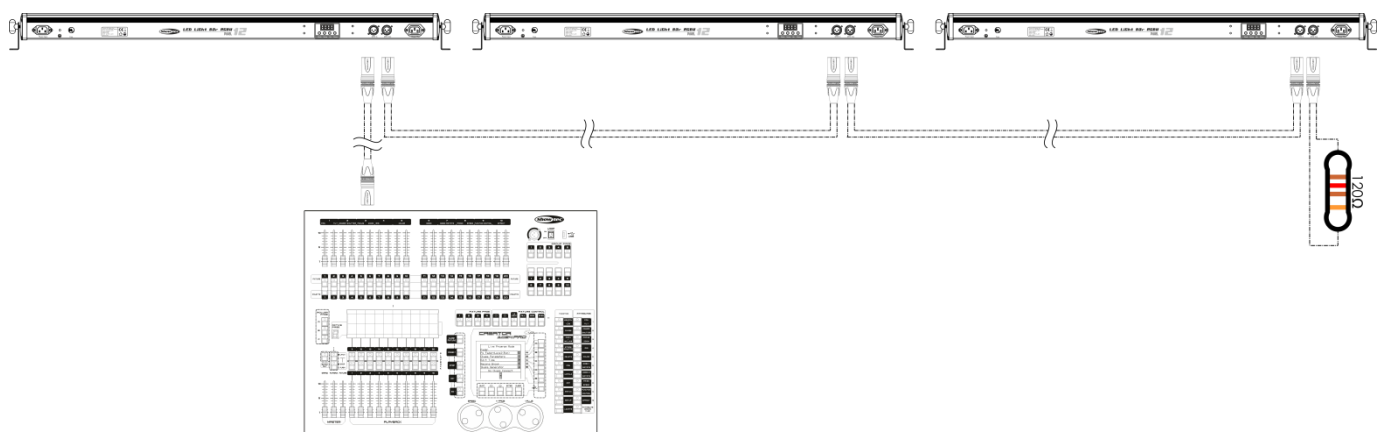

Fig. 03

Note: Link all cables before connecting electric power!

Fixture Linking

You will need a serial data link to run light shows of one or more fixtures using a DMX-512 controller or to run synchronized shows on two or more fixtures set to a master/slave operating mode. The combined number of channels required by all the fixtures on a serial data link determines the number of fixtures the data link can support.

The LED Lightbar 12 Pixel uses up to 48 channels.

Important:

Fixtures on a serial data link must be daisy chained in one single line. To comply with the EIA-485 standard no more than 30 devices should be connected on one data link. Connecting more than 30 fixtures on one serial data link without the use of a DMX optically isolated splitter may result in deterioration of the digital DMX signal.
Maximum recommended DMX data link distance: 100 meters
Maximum recommended number of LED Lightbars 12 Pixel on a DMX data link: 30 fixtures



Data Cabling

To link fixtures together you must obtain data cables. You can purchase DAP Audio certified DMX cables directly from a dealer/distributor or construct your own cable. If you choose to create your own cable please use data-grade cables that can carry a high quality signal and are less prone to electromagnetic interference.

DAP Audio DMX Data Cables

- DAP Audio Basic microphone cable for allround use. bal. XLR/M 3-pin > XLR/F 3-pin. **Ordercode** FL01150 (1,5 m), FL013 (3 m), FL016 (6 m), FL0110 (10 m), FL0115 (15 m), FL0120 (20 m).
- DAP Audio X-type data cable XLR/M 3-pin > XLR/F 3-pin. **Ordercode** FLX0175 (0,75 m), FLX01150 (1,5 m), FLX013 (3 m), FLX016 (6 m), FLX0110 (10 m).
- DAP Audio cable for the demanding user with exceptional audio-qualities and connector made by Neutrik®. **Ordercode** FL71150 (1,5 m), FL713 (3 m), FL716 (6 m), FL7110 (10 m).
- DAP Audio cable for the demanding user with exceptional audio-qualities and connector made by Neutrik®. **Ordercode** FL7275 (0,75 m), FL72150 (1,5 m), FL723 (3 m), FL726 (6 m), FL7210 (10 m).
- DAP Audio 110 Ohm cable with digital signal transmission. **Ordercode** FL0975 (0,75 m), FL09150 (1,5 m), FL093 (3 m), FL096 (6 m), FL0910 (10 m), FL0915 (15 m), FL0920 (20 m).
- DAP Audio DMX adapter: 3-pin/5-pin. **Ordercode** FLA30.

Control Panel

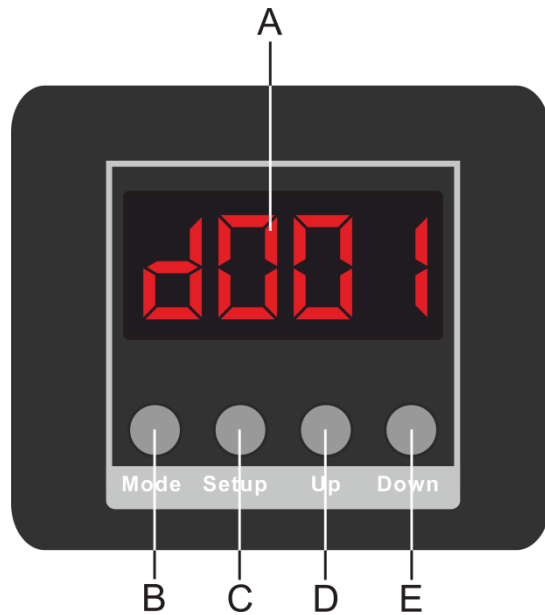

- A. LED Display
- B. Mode button
- C. Setup Button
- D. Up Button
- E. Down Button

Fig. 04

DMX Control Mode

The fixtures are individually addressed on a data-link and connected to the controller. The fixtures respond to the DMX signal from the controller. (When you select the DMX address and save it, the controller will display the saved DMX address the next time.)

DMX Addressing

The control panel on the backside of the device allows you to assign the DMX fixture address, which is the first channel from which the LED Lightbar 12 Pixel will respond to the controller. Please note when you use the controller, the unit has up to **48** channels. When using multiple LED Lightbars 12 Pixel, make sure you set the DMX addresses right. Therefore, the DMX address of the first LED Lightbar 12 Pixel should be **1(001)**; the DMX address of the second LED Lightbar 12 Pixel should be **1+48=49 (049)**; the DMX address of the third LED Lightbar 12 Pixel should be **48+49=97 (097)**, etc. Please, be sure that you do not have any overlapping channels in order to control each LED Lightbar 12 Pixel correctly. If two or more LED Lightbars 12 Pixel are addressed similarly, they will work similarly.

Controlling:

After having addressed all LED Lightbars 12 Pixel, you may now start operating these via your lighting controller.

Note: After switching on, the LED Lightbar 12 Pixel will automatically detect whether DMX 512 data is received or not. The problem may be:

- The XLR cable from the controller is not connected with the input of the LED Lightbar 12 Pixel.
- The controller is switched off or defective, the cable or connector is defective, or the signal wires are swapped in the input connector.

Note: It is necessary to insert a XLR termination plug (with 120 Ohm) in the last fixture in order to ensure proper transmission on the DMX data link.

⚠ Display Off after 20 seconds ⚠

When no button is pressed for 20 seconds, the display will turn off. To light up the display, you have to press the **Mode**, **Setup**, **Up** or **Down** button. Once you have pressed the button, the display will light up.

When the powercable is plugged in and you press the **Setup** or **Mode** button immediately, the display will show the temperature detection value. If the temperature is abnormal, the display will show **F 16.7**, and the LEDs of the fixture will be red 3s.

Menu overview

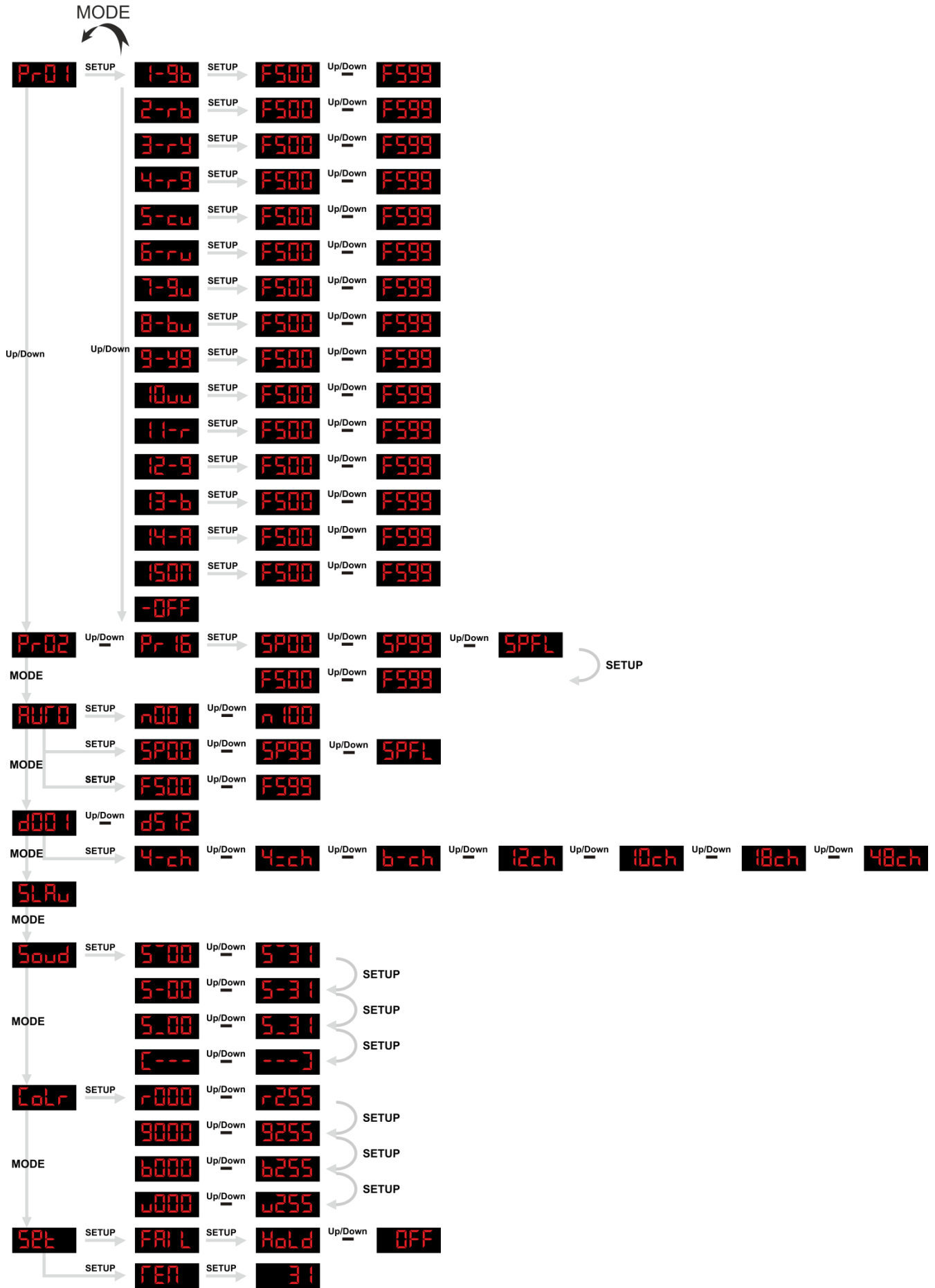

Main Menu Options







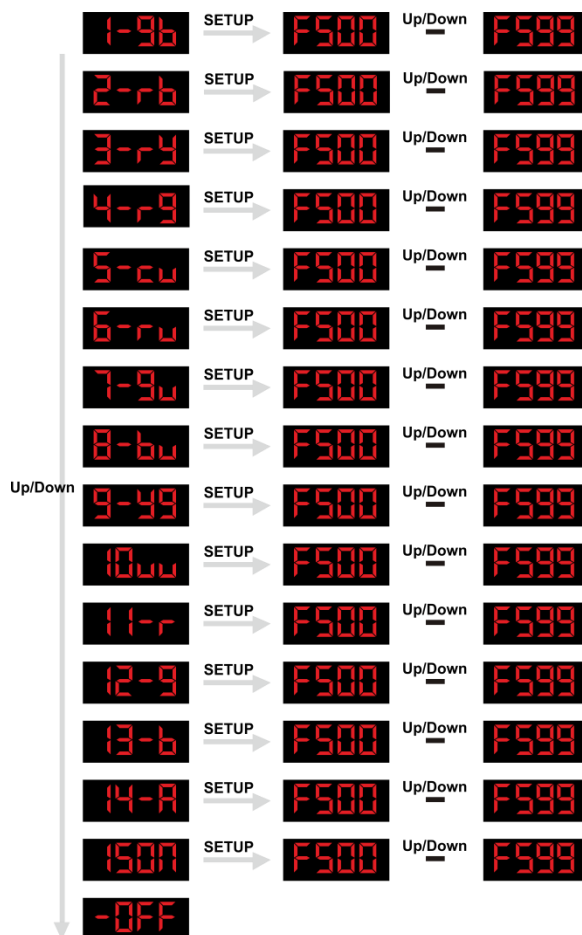

Built-in Programs

With this menu you can choose a built-in program.

- 01) Press the **Mode** button on the device, until the display shows **Pr01**.
- 02) You can choose 16 built-in programs **Pr01** ^{Up/Down} **Pr16**, by using the **Up** and **Down** buttons.
- 03) If you choose **Pr01** and you press **Setup** you can choose between 15 programs and Off with the **Up** and **Down** buttons.



- 04) Press **Setup** again and you can set the strobe value by using the **Up** and **Down** buttons.
- 05) Press the **Mode** button to go back to   .
- 06) With the **Up** and **Down** buttons you can choose between   .
- 07) Press the **Setup** button to set the speed or strobe value.

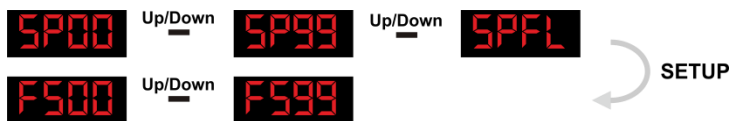











- 08) Use the **Up** and **Down** buttons to set the speed and strobe value between 0-99 or **SPFL**.

Auto Run Program

With this menu you can set the Auto run mode of the LED Lightbar 12 Pixel.







- 01) Press the **Mode** button on the device, until the display shows .
- 02) The LED Lightbar will start automatically with its built-in program.
- 03) Press the **Setup** button to enter the submenu.



- 04) With    you can set the frequency of each step of the Auto program.
- 05) With      you can set the speed of the Auto program.
- 06) With    you can set the frequency of the strobe of the Auto program.
- 07) You can scroll through these options with the **Setup** button.
- 08) With the **Up** and **Down** buttons you can adjust the options.

DMX Mode

With this menu you can set the DMX address and choose a DMX configuration.

- 01) Press the **Mode** button, until the display shows .
- 02) You can choose 512 different DMX addresses.
- 03) Use the **Up** and **Down** buttons to select the required address between   .
- 04) You can also press the **Setup** button to choose a different DMX Mode   .

	4 Channels
	4 Channels
	6 Channels
	12 Channels
	10 Channels
	18 Channels
	48 Channels

Master / slave addressing

Master

- 01) The default setting for this device is master.
- 02) Only one fixture can be the master.

Note:

- Disconnect the fixture from the DMX controller before master/slave operating, otherwise data collisions may occur and the fixtures will not work properly!
- In master/slave mode, the master fixture can execute the built-in programs, all the slave fixtures will work the same.
- When operating the master/slave chain, you can identify the master fixture from the slave fixtures easily. The master doesn't have any cable plugged into the DMX input connector.

Slave control

This function allows you to control the slaves from the master's control panel in a master/slave setup.

- 01) Only 1 fixture can be the master, the others have to be Slaves. The Default setting for a device is Master. So on the first device you don't have to change anything.

On the slave devices you must press the **Mode** button until the display shows **SLAV**.

- 02) All slave devices must have address **0001**.

Sound control Mode

With this menu you can set the sensitivity of the sound mode from the LED Lightbar 12 Pixel.

- 01) Press the **Mode** button on the device, until the display shows **Sound**.
- 02) Press the **Setup** button to enter the submenu.



- 03) You can scroll through these options with the **Setup** button.

- 04) You can choose between 3 sound modes **5 00** ^{Up/Down} **5 31**, **5-00** ^{Up/Down} **5-31** or **5.00** ^{Up/Down} **5.31**.

- 05) With the mode **[---]**, the LED Lightbar will react to the beat of the music from the leftside to the rightside of the bar.

- 06) With the mode **---]**, the LED Lightbar will react to the beat of the music from the rightside to the leftside of the bar.

- 07) Turn on the music and the LED Lightbar 12 Pixel will react to the beat of the music.



You can set the sensitivity from low-sensitivity to high-sensitivity between SU.00 - SU.31 with the **Up** and **Down** buttons.

Static Color Mode

With this menu you can create a static color.

- 01) Press the **Mode** button, until the display shows **Colr**.
- 02) Press the **Setup** button to make a color.

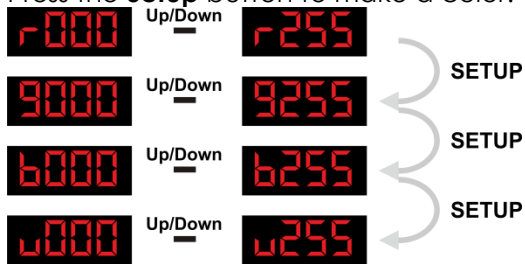

- 03) With this sub menu you can set 4 static colors of the LED Lightbar 12 Pixel. You can choose **Red, Green, Blue** or **White** by pressing the **Setup** button. Use the **Up / Down** buttons to set the values of each individual color from 000-255.

Settings

With this menu you can set the DMX fail of the LED Lightbar 12 Pixel and you can see the temperature.

- 01) Press the **Mode** button, until the display shows **SEt**.
- 02) Use the **Setup** button to choose **FAIL**.
- 03) Press the **Setup** button again and use the **Up** and **Down** buttons to choose between **Hold** mode and **OFF** mode.
- 01) When you choose **Hold**, the LED Lightbar 12 Pixel will remember the last settings and will not go out if there is no DMX signal.
- 04) When you choose **OFF**, the LED Lightbar 12 Pixel will go out if there is no DMX signal.
- 05) Press the **Setup** button again and the display will show **TEMP**.
- 06) Press **Setup** again and you can see the actual temperature **31**.
- 07) If the temperature is too high, the display will show **TEr**.

Reset factory settings

Switch the power off and hold at the same time the **Mode** and **Up** button.

Switch the power on for 5 seconds and release the **Mode** and **Up** button.

The LED Lightbar 12 Pixel will reset to the factory settings. The fixture will start up in the Auto Run mode.

DMX Channels**4 DMX Channels****Channel 1 – Pixel Programs**

2-24	Program 1
25-49	Program 2
50-74	Program 3
75-99	Program 4
100-124	Program 5
125-149	Program 6
150-174	Program 7
175-199	Program 8
200-224	Program 9
225-249	Program 10
250-255	Program 11

Channel 2 – Color running Programs

2-35	Program 1
36-53	Program 2
54-71	Program 3
72-89	Program 4
90-107	Program 5
108-125	Program 6
126-143	Program 7
144-161	Program 8
162-179	Program 9
180-197	Program 10
198-215	Program 11
216-233	Program 12
234-251	Program 13
252-255	Program 14

Channel 3 – Speed

0-255	Gradual speed adjustment, from slow to fast
-------	---

Channel 4 – Linear Strobe

2-255	Strobe intensity, from slow to fast (0-20 Hz)
-------	---

4 DMX Channels**Channel 1 – Red Dimmer intensity**

0-255	Red from 0 – 100%
-------	-------------------

Channel 2 – Green Dimmer intensity

0-255	Green from 0 – 100%
-------	---------------------

Channel 3 – Blue Dimmer intensity

0-255	Blue from 0 – 100%
-------	--------------------

Channel 4 – White Dimmer intensity

0-255	White from 0 – 100%
-------	---------------------

6 DMX Channels 6-ch

Channel 1 – Dimmer (Colors RGBW must be open )
 0-255 From black to brightest

Channel 2 – Linear Strobe (CH1, CH3, CH4, CH5 or CH6 must be set between 001-255 )
 0-255 Strobe intensity, from slow to fast (0-20Hz, color strobe selected by CH3-CH6)

Channel 3 – Red Dimmer intensity (CH1 must be set between 001-255 )
 0-255 Red from 0 – 100%

Channel 4 – Green Dimmer intensity (CH1 must be set between 001-255 )
 0-255 Green from 0 – 100%

Channel 5 – Blue Dimmer intensity (CH1 must be set between 001-255 )
 0-255 Blue from 0 – 100%

Channel 6 – White Dimmer intensity (CH1 must be set between 001-255 )
 0-255 White from 0 – 100%

12 DMX Channels 12ch

Channel 1 – Dimmer
 0-255 From black to brightest

Channel 2 – Linear Strobe (CH1, CH4- CH6 or CH9-CH12 must be set between 001-255 )
 2-255 Strobe intensity, from slow to fast (0-20Hz)

Channel 3 – Random Strobe (CH1, CH4- CH6 or CH9-CH12 must be set between 001-255 )
 2-255 Random strobe

Channel 4 – Color presets (CH1 must be set between 001-255 )

2-6	Color 1 (R255, G000, B000, W000)
7-13	Color 2 (R255, G000, B000, W100)
14-20	Color 3 (R255, G000, B000, W200)
21-27	Color 4 (R255, G050, B000, W000)
28-34	Color 5 (R255, G150, B000, W000)
35-41	Color 6 (R255, G255, B000, W000)
42-48	Color 7 (R255, G255, B000, W075)
49-55	Color 8 (R255, G255, B000, W255)
56-62	Color 9 (R000, G255, B000, W150)
63-69	Color 10 (R000, G255, B000, W050)
70-76	Color 11 (R000, G255, B000, W000)
77-83	Color 12 (R000, G255, B050, W000)
84-90	Color 13 (R000, G255, B150, W000)
91-97	Color 14 (R000, G255, B255, W000)
98-104	Color 15 (R000, G255, B255, W075)
105-111	Color 16 (R000, G255, B255, W150)
112-118	Color 17 (R000, G100, B255, W255)
119-125	Color 18 (R000, G000, B255, W100)
126-132	Color 19 (R000, G000, B255, W050)

133-139	Color 20 (R000, G000, B255, W000)
140-146	Color 21 (R075, G000, B255, W000)
147-153	Color 22 (R160, G000, B255, W000)
154-160	Color 23 (R255, G000, B255, W000)
161-167	Color 24 (R255, G000, B175, W000)
168-174	Color 25 (R255, G000, B100, W000)
175-181	Color 26 (R255, G000, B100, W050)
182-188	Color 27 (R255, G000, B025, W050)
189-195	Color 28 (R255, G000, B025, W025)
196-202	Color 29 (R255, G000, B025, W000)
203-209	Color 30 (R000, G000, B000, W255)
210-216	Color 31 (R075, G075, B000, W255)
217-223	Color 32 (R000, G000, B100, W255)
224-255	Color 33 (R255, G255, B255, W255)

Channel 5 – Pixel Programs (CH1 and CH7 must be set between 001-255 )

2-24	Program 1
25-49	Program 2
50-74	Program 3
75-99	Program 4
100-124	Program 5
125-149	Program 6
150-174	Program 7
175-199	Program 8
200-224	Program 9
225-249	Program 10
250-255	Program 11

Channel 6 – Color running Programs (CH1 and CH7 must be set between 001-255 )

2-35	Program 1
36-53	Program 2
54-71	Program 3
72-89	Program 4
90-107	Program 5
108-125	Program 6
126-143	Program 7
144-161	Program 8
162-179	Program 9
180-197	Program 10
198-215	Program 11
216-233	Program 12
234-251	Program 13
252-255	Program 14

Channel 7 – Speed

0-255	Gradual speed adjustment, from slow to fast
-------	---

Channel 8 – Sound mode

0-50	No function
51-255	Gradual adjustment Sensitivity, from 0-100%

Channel 9 – Red Dimmer intensity (CH1 must be set between 001-255 ⚠)
0-255 Red from 0 – 100%

Channel 10 – Green Dimmer intensity (CH1 must be set between 001-255 ⚠)
0-255 Green from 0 – 100%

Channel 11 – Blue Dimmer intensity (CH1 must be set between 001-255 ⚠)
0-255 Blue from 0 – 100%

Channel 12 – White Dimmer intensity (CH1 must be set between 001-255 ⚠)
0-255 White from 0 – 100%

10 DMX Channels 10ch

Channel 1 – Dimmer
0-255 From black to brightest

Channel 2 – Linear Strobe (CH1, CH3-CH10 must be set between 001-255 ⚠)
2-255 Strobe intensity, from slow to fast (0-20Hz)

Channel 3 – Red Dimmer intensity section 1 (CH1 must be set between 001-255 ⚠)
0-255 Red from 0 – 100%



Channel 4 – Green Dimmer intensity section 1 (CH1 must be set between 001-255 ⚠)
0-255 Green from 0 – 100%



Channel 5 – Blue Dimmer intensity section 1 (CH1 must be set between 001-255 ⚠)
0-255 Blue from 0 – 100%



Channel 6 – White Dimmer intensity section 1 (CH1 must be set between 001-255 ⚠)
0-255 White from 0 – 100%



Channel 7 – Red Dimmer intensity section 2 (CH1 must be set between 001-255 ⚠)

0-255 Red from 0 – 100%



Channel 8– Green Dimmer intensity section 2 (CH1 must be set between 001-255 ⚠)

0-255 Green from 0 – 100%



Channel 9 – Blue Dimmer intensity section 2 (CH1 must be set between 001-255 ⚠)

0-255 Blue from 0 – 100%

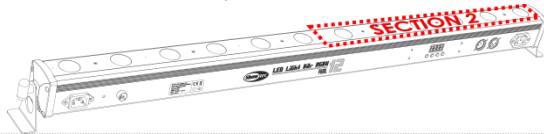

Channel 10 – White Dimmer intensity section 2 (CH1 must be set between 001-255 ⚠)

0-255 White from 0 – 100%



18 DMX Channels **18ch**

Channel 1 – Dimmer

0-255 From black to brightest

Channel 2 – Linear Strobe (CH1, CH3-CH18 must be set between 001-255 ⚠)

2-255 Strobe intensity, from slow to fast (0-20Hz)

Channel 3 – Red Dimmer intensity section 1 (CH1 must be set between 001-255 ⚠)

0-255 Red from 0 – 100%



Channel 4– Green Dimmer intensity section 1 (CH1 must be set between 001-255 ⚠)

0-255 Green from 0 – 100%



Channel 5 – Blue Dimmer intensity section 1 (CH1 must be set between 001-255 ⚠)

0-255 Blue from 0 – 100%

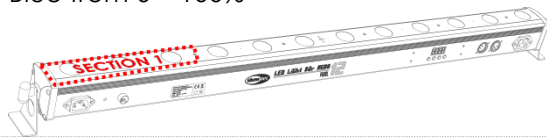

Channel 6 – White Dimmer intensity section 1 (CH1 must be set between 001-255 ⚠)

0-255 White from 0 – 100%



Channel 7 – Red Dimmer intensity section 2 (CH1 must be set between 001-255 ⚠)

0-255 Red from 0 – 100%



Channel 8 – Green Dimmer intensity section 2 (CH1 must be set between 001-255 ⚠)

0-255 Green from 0 – 100%



Channel 9 – Blue Dimmer intensity section 2 (CH1 must be set between 001-255 ⚠)

0-255 Blue from 0 – 100%



Channel 10 – White Dimmer intensity section 2 (CH1 must be set between 001-255 ⚠)

0-255 White from 0 – 100%



Channel 11 – Red Dimmer intensity section 3 (CH1 must be set between 001-255 ⚠)

0-255 Red from 0 – 100%

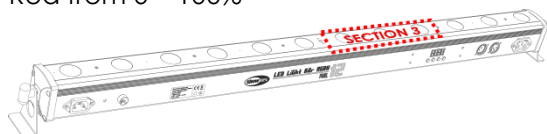

Channel 12 – Green Dimmer intensity section 3 (CH1 must be set between 001-255 ⚠)
0-255 Green from 0 – 100%

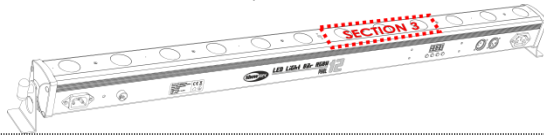

Channel 13 – Blue Dimmer intensity section 3 (CH1 must be set between 001-255 ⚠)
0-255 Blue from 0 – 100%

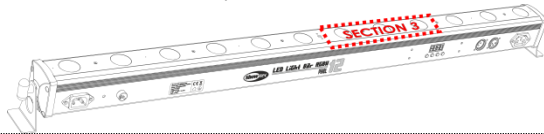

Channel 14 – White Dimmer intensity section 3 (CH1 must be set between 001-255 ⚠)
0-255 White from 0 – 100%



Channel 15 – Red Dimmer intensity section 4 (CH1 must be set between 001-255 ⚠)
0-255 Red from 0 – 100%



Channel 16 – Green Dimmer intensity section 4 (CH1 must be set between 001-255 ⚠)
0-255 Green from 0 – 100%



Channel 17 – Blue Dimmer intensity section 4 (CH1 must be set between 001-255 ⚠)
0-255 Blue from 0 – 100%



Channel 18 – White Dimmer intensity section 4 (CH1 must be set between 001-255 ⚠)
0-255 White from 0 – 100%



48 DMX Channels 

Channel 1 – Red Pixel LED 1

0-255 Red from 0 – 100%

Channel 2 – Green Pixel LED 1

0-255 Green from 0 – 100%

Channel 3 – Blue Pixel LED 1

0-255 Blue from 0 – 100%

Channel 4 – White Pixel LED 1

0-255 White from 0 – 100%

Channel 5 – Red Pixel LED 2

0-255 Red from 0 – 100%

Channel 6 – Green Pixel LED 2

0-255 Green from 0 – 100%

Channel 7 – Blue Pixel LED 2

0-255 Blue from 0 – 100%

Channel 8 – White Pixel LED 2

0-255 White from 0 – 100%

Channel 9 – Red Pixel LED 3

0-255 Red from 0 – 100%

Channel 10 – Green Pixel LED 3

0-255 Green from 0 – 100%

Channel 11 – Blue Pixel LED 3

0-255 Blue from 0 – 100%

Channel 12 – White Pixel LED 3

0-255 White from 0 – 100%

Channel 13 – Red Pixel LED 4

0-255 Red from 0 – 100%

Channel 14 – Green Pixel LED 4

0-255 Green from 0 – 100%

Channel 15 – Blue Pixel LED 4

0-255 Blue from 0 – 100%

Channel 16 – White Pixel LED 4

0-255 White from 0 – 100%

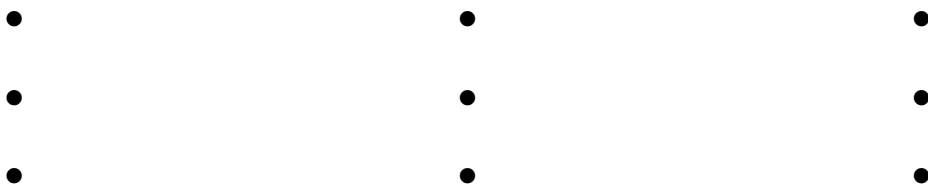

Channel 33 – Red Pixel LED 9

0-255 Red from 0 – 100%

Channel 34 – Green Pixel LED 9

0-255 Green from 0 – 100%

Channel 35 – Blue Pixel LED 9

0-255 Blue from 0 – 100%

Channel 36 – White Pixel LED 9

0-255 White from 0 – 100%

Channel 37 – Red Pixel LED 10

0-255 Red from 0 – 100%

Channel 38 – Green Pixel LED 10

0-255 Green from 0 – 100%

Channel 39 – Blue Pixel LED 10

0-255 Blue from 0 – 100%

Channel 40 – White Pixel LED 10

0-255 White from 0 – 100%

Channel 41 – Red Pixel LED 11

0-255 Red from 0 – 100%

Channel 42 – Green Pixel LED 11

0-255 Green from 0 – 100%

Channel 43 – Blue Pixel LED 11

0-255 Blue from 0 – 100%

Channel 44 – White Pixel LED 11

0-255 White from 0 – 100%

Channel 45 – Red Pixel LED 12

0-255 Red from 0 – 100%

Channel 46 – Green Pixel LED 12

0-255 Green from 0 – 100%

Channel 47 – Blue Pixel LED 12

0-255 Blue from 0 – 100%

Channel 48 – White Pixel LED 12

0-255 White from 0 – 100%

Maintenance

The operator has to make sure that safety-relating and machine-technical installations are to be inspected by an expert after every year in the course of an acceptance test.

The operator has to make sure that safety-relating and machine-technical installations are to be inspected by a skilled person once a year.

The following points have to be considered during the inspection:

- 01) All screws used for installing the device or parts of the device have to be tightly connected and must not be corroded.
- 02) There may not be any deformations on housings, fixations and installation spots.
- 03) Mechanically moving parts like axles, eyes and others may not show any traces of wearing.
- 04) The electric power supply cables must not show any damages or material fatigue.

The Showtec LED Lightbar 12 Pixel requires almost no maintenance. However, you should keep the unit clean. Otherwise, the fixture's light-output will be significantly reduced. Disconnect the mains power supply and then wipe the cover with a damp cloth. Wipe the front glass panel clean with glass cleaner and a soft cloth. Do not use alcohol or solvents. The front glass panel will require weekly cleaning, as smoke-fluid tends to build up residues, reducing the light-output very quickly. Do not immerse in liquid. Keep connections clean. Disconnect electric power, and then wipe the DMX and audio connections with a damp cloth. Make sure connections are thoroughly dry before linking equipment or supplying electric power.

Replacing a Fuse

Power surges, short-circuit or inappropriate electrical power supply may cause a fuse to burn out. If the fuse burns out, the product will not function whatsoever. If this happens, follow the directions below:

- 01) Unplug the unit from electric power source.
- 02) Insert a flat-head screwdriver into a slot in the fuse cover. Gently pry up the fuse cover. the fuse will come out.
- 03) Remove the used fuse. If brown or unclear, it is burned out.
- 04) Insert the replacement fuse into the holder where the old fuse was. Reinsert the fuse cover. Be sure to use a fuse of the same type and specification. See the product specification label for details.

Troubleshooting

No Light

This troubleshooting guide is meant to help solve simple problems.

If a problem occurs, follow the steps below in sequence until a solution is found. Once the unit operates properly, do not carry out the following steps.

If the light effect does not operate properly, refer servicing to a technician.

Suspect three potential problem areas as the power supply, the LEDs, the fuse.

- 01) Power supply. Check that the unit is plugged into an appropriate power supply.
- 02) The LEDs. Return the LED Lightbar 12 Pixel to your Showtec dealer.
- 03) The fuse. Replace the fuse. See page 26 for replacing the fuse.
- 04) If all of the above appears to be in order, switch the unit on again.
- 05) If you are unable to determine the cause of the problem, do not open the LED Lightbar 12 Pixel, as this may damage the unit and the warranty will become void.
- 06) Return the device to your Showtec dealer.

No Response to DMX

Suspect the DMX cable or connectors, a controller malfunction, a light effect DMX card malfunction.

- 01) Check the DMX setting. Make sure that DMX addresses are correct.
- 02) Check the DMX cable: Unplug the unit; change the DMX cable; then reconnect to electrical power. Try your DMX control again.
- 03) Determine whether the controller or light effect is to blame. Does the controller operate properly with other DMX products? If not, take the controller in for repair. If it does, take the DMX cable and the light effect to a qualified technician.

Problem	Probable cause(s)	Solution
One or more fixtures do not function at all	No power to the fixture	<ul style="list-style-type: none"> Check if power is switched on and cables are plugged in.
	Primary fuse blown	<ul style="list-style-type: none"> Replace fuse
Fixtures reset correctly, but all respond erratically or not at all to the controller	The controller is not connected.	<ul style="list-style-type: none"> Connect controller.
	3-pin XLR Out of the controller does not match XLR Out of the first fixture on the link (i.e. signal is reversed)	<ul style="list-style-type: none"> Install a phase reversing cable between the controller and the first fixture on the link
Fixtures reset correctly, but some respond erratically or not at all to the controller	Poor data quality	<ul style="list-style-type: none"> Check data quality. If much lower than 100 percent, the problem may be a bad data link connection, poor quality or broken cables, missing termination plug, or a defective fixture disturbing the link
	Bad data link connection	<ul style="list-style-type: none"> Inspect connections and cables. Correct poor connections. Repair or replace damaged cables
	Data link not terminated with 120 Ohm termination plug	<ul style="list-style-type: none"> Insert termination plug in output jack of the last fixture on the link
	Incorrect addressing of the fixtures	<ul style="list-style-type: none"> Check address setting
	One of the fixtures is defective and disturbs data transmission on the link	<ul style="list-style-type: none"> Bypass one fixture at a time until normal operation is restored: unplug both connectors and connect them directly together. Have the defective fixture serviced by a qualified technician
	3-pin XLR Out on the fixtures does not match (pins 2 and 3 reversed)	<ul style="list-style-type: none"> Install a phase-reversing cable between the fixtures or swap pin 2 and 3 in the fixture that behaves erratically
No light or lamp cuts out intermittently	Fixture is too hot	<ul style="list-style-type: none"> Allow the fixture to cool down Clean the fan Turn up the air conditioning
	LEDs damaged	<ul style="list-style-type: none"> Disconnect the fixture and return it to your dealer
	The power supply settings do not match local AC voltage and frequency	<ul style="list-style-type: none"> Disconnect fixture. Check settings and correct if necessary

Product Specifications

Model:	Showtec LED Lightbar 12 Pixel
Input Voltage:	100-240V AC, 50/60Hz
Consumption Power	20 Watt
Drive current:	100 mA
Refresh rate:	2 Khz
DMX linking:	30pcs
Fuse:	T1L / 250V
Dimensions:	1080 x 65 x 88 mm (LxWxH) (incl. brackets)
Weight:	2,14 kg
Operating and Programming:	
Signal pin OUT:	Pin 1 (earth), pin 2 (-), pin 3 (+)
DMX Mode:	4, 4, 6, 10, 12, 18 and 48 DMX channel operation
Signal input:	3-pin XLR male
Signal output:	3-pin XLR female
Electro-mechanical effects:	
Light source:	12 x 2W RGBW
Lux @2m:	500 (Full On)
Beam Angle:	30 °
Sections selectable:	2, 4 or 12
Dimmer:	0-100%
Strobe:	0-20Hz
Color Range:	RGBW
Cooling:	aluminum heatsink
Display:	LED display
Housing:	aluminum
IP rating:	IP-20
DMX-control:	DMX512 via standard DMX-controller
Control:	DMX, Auto, Sound, Static, Slave
Connections:	XLR Data in/out (XLR 3-pin), IEC Power In and IEC power Out (Max. 10A)
Built-in microphone	
Max. ambient temperature t_a :	40°C
Max. housing temperature t_B :	80°C
Minimum distance:	
Minimum distance from flammable surfaces:	0,5 m
Minimum distance to lighted object:	1 m

Design and product specifications are subject to change without prior notice



Website: www.Showtec.info

Email: service@highlite.nl

Dimensions

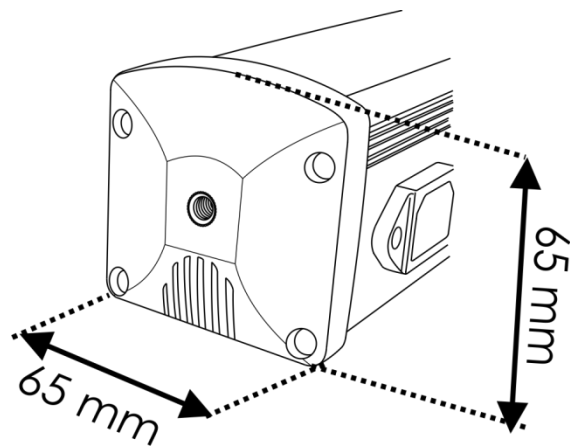
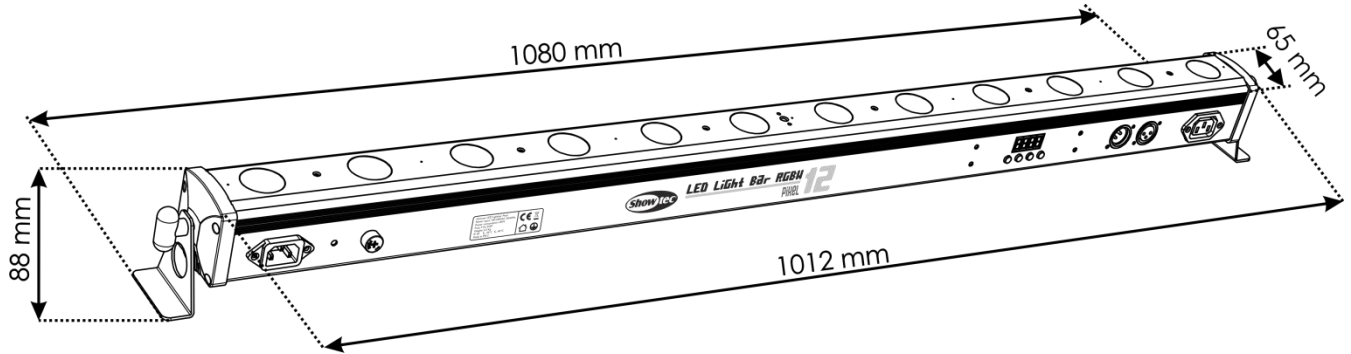



©2024 Showtec