

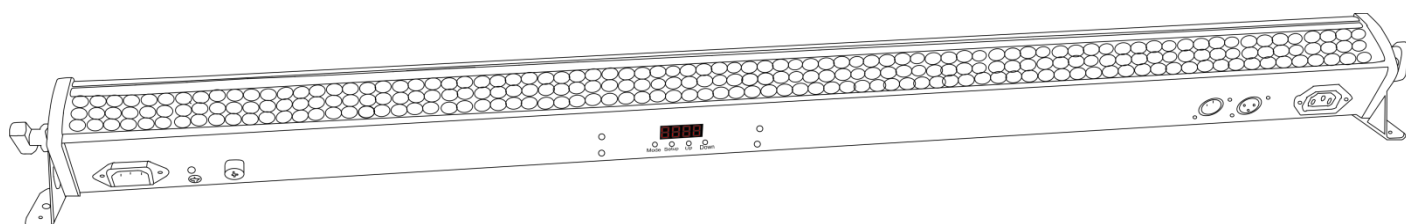

MANUAL



ENGLISH

LED light bar 8

V2

Ordercode: 42196

Table of contents

Warning	2
Safety Instructions	2
Operating Determinations	4
Rigging	4
Connection with the mains.....	5
Return Procedure	5
Claims.....	5
Description of the device	6
Optional accessories.....	6
Overview	7
Installation	7
Set Up and Operation	7
Control Modes.....	7
One Light Bar (Manual control)	7
One Light Bar (Built-in programs, Macro colors)	8
One Light Bar (Sound-control)	8
Multiple Light Bars (Master/Slave control).....	8
Multiple Light Bars (DMX512 Mode)	9
Fixture Linking.....	10
Data Cabling.....	10
Control Panel.....	11
DMX Control Mode.....	11
DMX Addressing.....	11
Menu overview	12
Main Menu Options	14
1. DMX Mode	14
2. Master / slave addressing	14
3. Sound control Mode	15
4. Static Color Mode	15
5. Built-in Programs.....	15
6. Auto Run Program	18
DMX Channels	19
3 DMX Channels (d-P1)	19
4 DMX Channels (d-P2)	19
14 DMX Channels (d-P3).....	19
26 DMX Channels (d-P4).....	20
2 DMX Channels (d-P5).....	22
7 DMX Channels (d-P6).....	23
Maintenance	24
Replacing a Fuse	24
Troubleshooting	25
No Light	25
No Response to DMX.....	25
Product Specifications	27
Dimensions	28
Notes	29

Warning



**For your own safety, please read this user manual carefully
before your initial start-up!**



Unpacking Instructions

Immediately upon receiving this product, carefully unpack the carton and check the contents to ensure that all parts are present, and have been received in good condition. Notify the dealer immediately and retain packing material for inspection if any parts appear damaged from shipping or the carton itself shows signs of mishandling. Save the carton and all packing materials. In the event that a fixture must be returned to the factory, it is important that the fixture be returned in the original factory box and packing.

Your shipment includes:

- Showtec LED Light Bar 8
- 2 brackets and screws
- Volex IEC powercable 1,5m
- User manual



LED Expected Lifespan

LEDs gradually decline in brightness over time. HEAT is the dominant factor that leads to the acceleration of this decline. Packaged in clusters, LEDs exhibit higher operating temperatures than in ideal or singular optimum conditions. For this reason when all color LEDs are used at their fullest intensity, life of the LEDs is significantly reduced. If improving your lifespan expectancy is of a higher priority, place care in providing for lower operational temperatures. This may include climatic-environmental and the reduction of overall projection intensity.



CAUTION!

**Keep this device away from rain and moisture!
Unplug mains lead before opening the housing!**



Safety Instructions

Every person involved with the installation, operation and maintenance of this device has to:

- be qualified
- follow the instructions of this manual



**CAUTION! Be careful with your operations.
With a dangerous voltage you can suffer
a dangerous electric shock when touching the wires!**



Before your initial start-up, please make sure that there is no damage caused by transportation. Should there be any, consult your dealer and do not use the device.

To maintain perfect condition and to ensure a safe operation, it is absolutely necessary for the user to follow the safety instructions and warning notes written in this manual.

Please consider that damages caused by manual modifications to the device are not subject to warranty.

This device contains no user-serviceable parts. Refer servicing to qualified technicians only.

IMPORTANT:

The manufacturer will not accept liability for any resulting damages caused by the non-observance of this manual or any unauthorized modification to the device.

- Never let the power cord come into contact with other cables! Handle the power cord and all connections with the mains with particular caution!
- Never remove warning or informative labels from the unit.
- Never use anything to cover the ground contact.
- Never place any material over the lens.
- Never look directly into the light source.
- Never leave any cables lying around.
- Do not insert objects into air vents.
- Do not connect this device to a dimmer pack.
- Do not switch the device on and off in short intervals, as this would reduce the device's life.
- Do not touch the device's housing bare-handed during its operation. Allow the fixture to cool for at least 5 minutes before handling.
- Do not shake the device. Avoid brute force when installing or operating the device.
- Only operate the fixture after having checked if the housing is firmly closed and all screws are tightly fastened.
- Only operate the device after having familiarized with its functions.
- Avoid flames and do not put close to flammable liquids or gases.
- Always keep case closed while operating.
- Always allow free air space of at least 50 cm around the unit for ventilation.
- Always disconnect power from the mains, when device is not used or before cleaning! Only handle the power cord by the plug. Never pull out the plug by tugging the power cord.
- Make sure that the device is not exposed to extreme heat, moisture or dust.
- Make sure that the available voltage is not higher than stated on the rear panel.
- Make sure that the power cord is never crimped or damaged. Check the device and the power cord from time to time.
- If the lens is obviously damaged, it has to be replaced, so that its functions are not impaired due to cracks or deep scratches.
- If device is dropped or struck, disconnect mains power supply immediately. Have a qualified engineer inspect for safety before operating.
- If the device has been exposed to drastic temperature fluctuation (e.g. after transportation), do not switch it on immediately. The arising condensation water might damage your device. Leave the device switched off until it has reached room temperature.
- If your Showtec device fails to work properly, discontinue use immediately. Pack the unit securely (preferably in the original packing material), and return it to your Showtec dealer for service.
- For adult use only. Device must be installed out of the reach of children. Never leave the unit running unattended.
- Never attempt to bypass the thermostatic switch or fuses.
- For replacement, use fuses of same type and rating only.
- The user is responsible for correct positioning and operating of the Light Bar 8. The manufacturer will not accept liability for damages caused by the misuse or incorrect installation of this device.
- This device falls under protection class I. Therefore it is essential to connect the yellow/green conductor to earth.
- Repairs, servicing and electric connection must be carried out by a qualified technician.
- **WARRANTY:** Till one year after date of purchase.

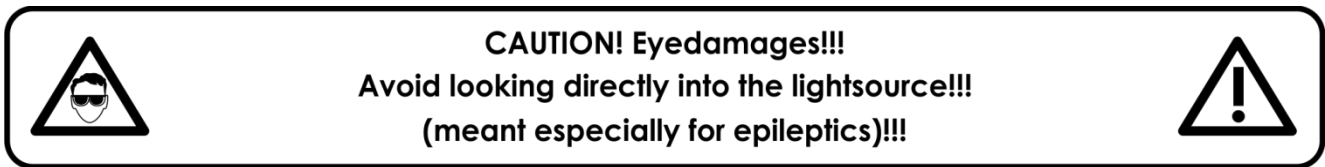

Operating Determinations

- This device is not designed for permanent operation. Consistent operation breaks will ensure that the device will serve you for a long time without defects.
- The minimum distance between light output and the illuminated surface must be bigger than 0,5 meter.
- The maximum ambient temperature $t_a = 40\text{ °C}$ must never be exceeded.
- In order to eliminate wear and improve the device's lifespan, during periods of non-use, completely disconnect from power source via breaker or by unplugging.
- The relative humidity must not exceed 50 % with an ambient temperature of 40 °C .
- If this device is operated in any other way, than the one described in this manual, the product may suffer damages and the warranty becomes void.
- Any other operation may lead to dangers like short-circuit, burns, electric shock, crash etc.

You endanger your own safety and the safety of others!

Rigging

Please follow the European and national guidelines concerning rigging, trussing and all other safety issues.

Do not attempt the installation yourself!

Always let the installation be carried out by an authorized dealer!

Procedure:

- If the Light Bar is lowered from the ceiling or high joists, professional trussing systems have to be used.
- Use a clamp to mount the Light Bar, with the mounting bracket, to the trussing system.
- The Light Bar must never be fixed swinging freely in the room.
- The installation must always be secured with a safety attachment, e.g. an appropriate safety net or safety cable.
- When rigging, derigging or servicing the Light Bar, always make sure, that the area below the installation place is blocked and staying in the area is forbidden.

The Light Bar 8 can be placed on a flat stage floor or mounted to any kind of truss by a clamp.

Improper installation can cause serious injuries and/or damage of property!

Connection with the mains

Connect the device to the mains with the power-plug.

Always pay attention, that the right color cable is connected to the right place.

International	EU Cable	UK Cable	US Cable	Pin
L	BROWN	RED	YELLOW/COPPER	PHASE
N	BLUE	BLACK	SILVER	NEUTRAL
	YELLOW/GREEN	GREEN	GREEN	PROTECTIVE GROUND

Make sure that the device is always connected properly to the earth!

Improper installation can cause serious damage to people and property!

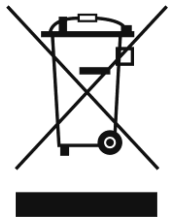

Return Procedure

Returned merchandise must be sent prepaid and in the original packing, call tags will not be issued. Package must be clearly labeled with a Return Authorization Number (RMA number). Products returned without an RMA number will be refused. Highlite will not accept the returned goods or any responsibility. Call Highlite 0031-455667723 or mail aftersales@highlite.com and request an RMA prior to shipping the fixture. Be prepared to provide the model number, serial number and a brief description of the cause for the return. Be sure to properly pack fixture, any shipping damage resulting from inadequate packaging is the customer's responsibility. Highlite reserves the right to use its own discretion to repair or replace product(s). As a suggestion, proper UPS packing or double-boxing is always a safe method to use.

Note: If you are given an RMA number, please include the following information on a piece of paper inside the box:

- 01) Your name.
- 02) Your address.
- 03) Your phone number.
- 04) A brief description of the symptoms.

Claims

The client has the obligation to check the delivered goods immediately upon delivery for any shortcomings and/or visible defects, or perform this check after our announcement that the goods are at their disposal. Damage incurred in shipping is the responsibility of the shipper; therefore the damage must be reported to the carrier upon receipt of merchandise.

It is the customer's responsibility to notify and submit claims with the shipper in the event that a fixture is damaged due to shipping. Transportation damage has to be reported to us within one day after receipt of the delivery.

Any return shipment has to be made post-paid at all times. Return shipments must be accompanied with a letter defining the reason for return shipment. Non-prepaid return shipments will be refused, unless otherwise agreed in writing.

Complaints against us must be made known in writing or by fax within 10 working days after receipt of the invoice. After this period complaints will not be handled anymore.

Complaints will only then be considered if the client has so far complied with all parts of the agreement, regardless of the agreement of which the obligation is resulting.

Description of the device

Features

The LED Light Bar 8 is a LED fixture from Showtec.

- LEDs: 240 RGB high intensity 10mm LEDs (Red 96, Green 72, Blue 72)
- Beam angle: 30 °
- Inexpensive batten effect with 8 sections
- Compact size
- Output: 800Lumen
- Lux @2m: 613,3
- Max. Distance: 15 m
- Power consumption @FO: 23 W
- Drive Current: 20 mA
- Refresh rate: 11,6 KHz
- Color Range: RGB
- Power Supply: 100-240V AC, 50/60Hz
- Control Mode: DMX512
- Dimmer: 0-100%
- Strobe: 0-17 Hz
- 3 pin female XLR socket and 3 pin male XLR socket
- IEC Power In and IEC power Out (Max. 10A)
- Linkable via 3-pin XLR cable
- Built-in microphone
- Black aluminum material
- Red LED Digital display
- Fuse: T1AL / 250V
- Built-in programs mode, Auto running mode, DMX mode, slave mode, sound-activated mode.
- DMX controlled
- Selectable 2, 3, 4, 7, 14 and 26 DMX channel operation
- Dimensions: 1070 x 65 x 88 mm (LXWXH)
- Weight: 1,58 kg

Note: Knowledge of DMX is required to fully utilize this unit.

Note: This device will only work in combination with the older model (42199 version1+2)
However the strobe speed, the program speed and the built-in programs may differ
All other models will not function together.

Optional accessories

- [D7012](#) Flightcase for LED Light Bar 8
- [D7595](#) Flightcase for LED Light Bar 8
- [70109B](#) Heavy Duty Pipe Clamp, SWL=35 kg
- [70359B](#) 50 mm Quick coupler
- [70365B](#) 50 mm Compact Half Coupler

Overview

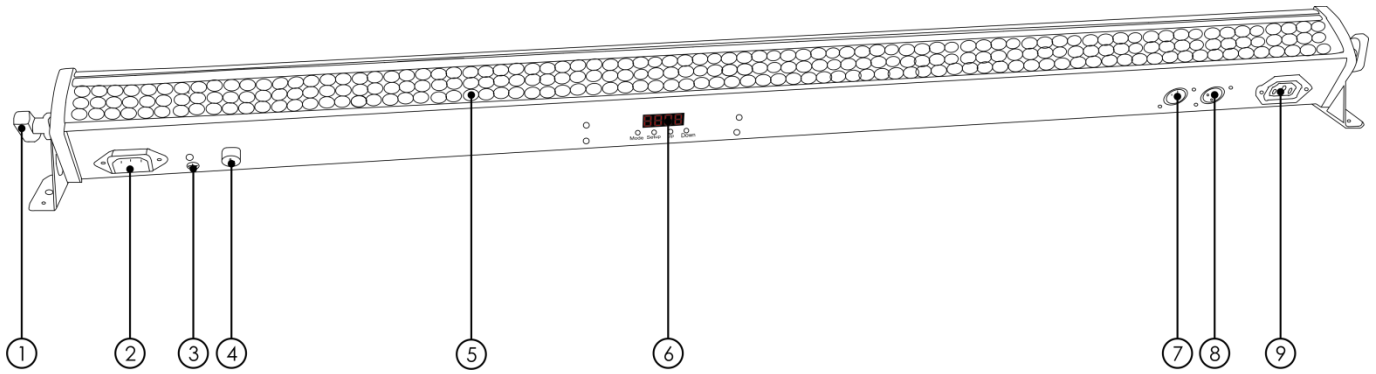

Fig. 01

- 01) Adjustment screw + mounting bracket for Truss mounting
- 02) IEC Power In
- 03) Ground
- 04) Fuse 1TA1L / 250V
- 05) Total LED Light Bar 240 LEDs
- 06) Menu Buttons + LED display
- 07) DMX signal connector (IN) 3-pin
- 08) DMX signal connector (OUT) 3-pin
- 09) IEC Power Out (Max. 10A)

Installation

Remove all packing materials from the LED Light Bar 8.

Check that all foam and plastic padding is removed. Connect all cables.

Do not supply power before the whole system is set up and connected properly.

Always disconnect from electric mains power supply before cleaning or servicing.

Damages caused by non-observance are not subject to warranty.

Set Up and Operation

Follow the directions below, as they pertain to your preferred operation mode.

Before plugging the unit in, always make sure that the power supply matches the product specification voltage. Do not attempt to operate a 120V specification product on 230V power, or vice versa.

Connect the device to the main power supply.

Control Modes

There are 6 modes:

- Manual control (Static)
- Built-in Programs
- Macro Colors (Auto Run)
- Sound-controlled
- Master/Slave
- DMX512

One Light Bar (Manual control)

01) Fasten the effect light onto firm trussing. Leave at least 0,5 meter on all sides for air circulation.

02) When the Light Bar is not connected by a DMX-cable, it functions as a stand-alone device.

03) If device is set to **LOFF**, then the fixture can be manually controlled.

04) Please see page 15 for more information about manual control Mode.

One Light Bar (Built-in programs, Macro colors)

- 01) Fasten the effect light onto firm trussing. Leave at least 0,5 meter on all sides for air circulation.
- 02) When the Light Bar is not connected by a DMX-cable, it functions as a stand-alone device.
- 03) If device is set to **P-01** or **AUTO**, then the fixture will play one of its built-in programs or show one of its macro colors. Please see pages 15-18 for more information about the built-in programs or macro colors.

One Light Bar (Sound-control)

- 01) Fasten the effect light onto firm trussing. Leave at least 0,5 meter on all sides for air circulation.
- 02) When the Light Bar is not connected by a DMX-cable, it functions as a stand-alone device.
- 03) Turn on the music. If device is set to **SUDD** (Audio) and you have pressed enter, then the fixture will react to the beat of the music. Please see page 15 for more information about the Sound-controlled mode.

Multiple Light Bars (Master/Slave control)

- 01) Fasten the effect light onto firm trussing. Leave at least 0,5 meter on all sides for air circulation.
- 02) Plug the end of the electric mains power cord into a proper electric power supply socket.
- 03) Use a 3-p XLR cable to connect the Light Bar and other devices.

The pins:



1. Earth
2. Signal (-)
3. Signal (+)

- 04) Link the units as shown in (Fig. 02), connect a DMX signal cable from the first unit's DMX "out" socket to the second unit's "in" socket. Repeat this process to link the second, and third units. You can use the same functions on the master device as described on page 15-18 (Built-in Programs). This means you can set your desired operation mode on the master device and all slave devices will react the same as the master device.

Multiple Light Bars (Master/Slave control)

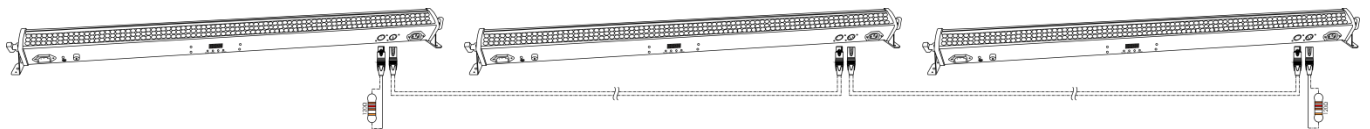
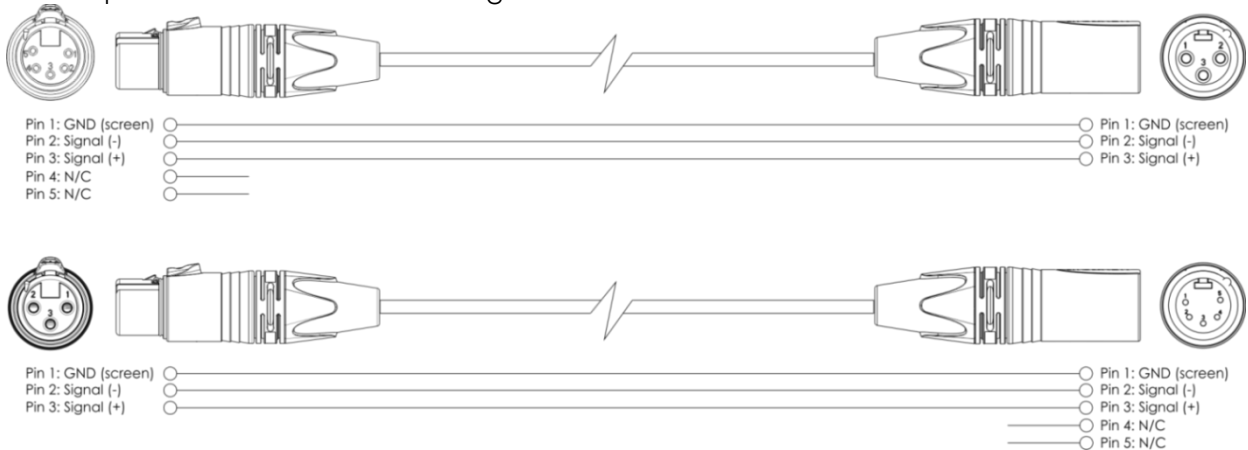

Fig. 02

Multiple Light Bars (DMX512 Mode)

- 01) Fasten the effect light onto firm trussing. Leave at least 0,5 meter on all sides for air circulation.
- 02) Plug the end of the electric mains power cord into a proper electric power supply socket.
- 03) Use a 3-p XLR cable to connect the Light Bar and other devices.



- 04) Link the units as shown in (Fig. 03), Connect a DMX signal cable from the first unit's DMX "out" socket to the second unit's "in" socket. Repeat this process to link the second and third units.
- 05) Supply electric power: Plug electric mains power cords into each unit's IEC socket, then plug the other end of the mains power cord into proper electric power supply sockets, starting with the first unit. Do not supply power before the whole system is set up and connected properly.

Multiple Light Bars DMX Set Up

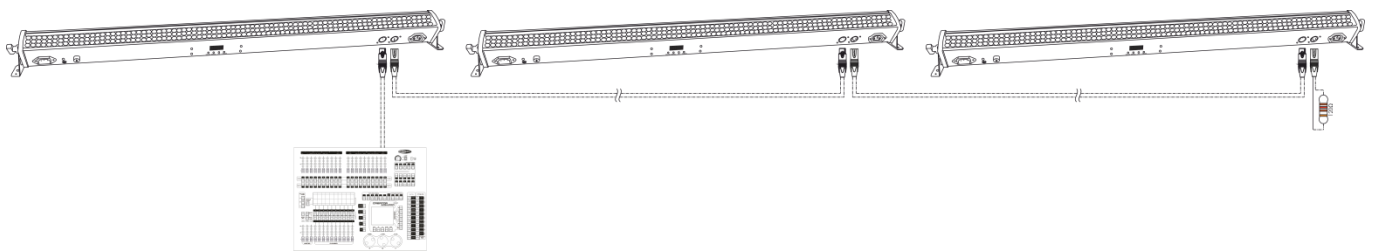

Fig. 03

Note: Link all cables before connecting electric power!

Fixture Linking

You will need a serial data link to run light shows of one or more fixtures using a DMX-512 controller or to run synchronized shows on two or more fixtures set to a master/slave operating mode. The combined number of channels required by all the fixtures on a serial data link determines the number of fixtures the data link can support.

The LED Light Bar 8 uses up to 26 channels.

Important: Fixtures on a serial data link must be daisy-chained in a single line. To comply with the EIA-485 standard, no more than 30 devices should be connected on one data link. Connecting more than 30 fixtures on one serial data link without the use of a DMX optically isolated splitter may result in deterioration of the digital DMX signal.
Maximum recommended DMX data link distance: 100 meters
Maximum recommended number of fixtures on a DMX data link: 30 fixtures



Data Cabling

To link fixtures together you must obtain data cables. You can purchase DAP Audio certified DMX cables directly from a dealer/distributor or construct your own cable. If you choose to create your own cable please use data-grade cables that can carry a high quality signal and are less prone to electromagnetic interference.

DAP Audio DMX Data Cables

- DAP Audio Basic microphone cable for allround use. bal. XLR/M 3-pin > XLR/F 3-pin. **Ordercode** FL01150 (1,5 m), FL013 (3 m), FL016 (6 m), FL0110 (10 m), FL0115 (15 m), FL0120 (20 m).
- DAP Audio X-type data cable XLR/M 3-pin > XLR/F 3-pin. **Ordercode** FLX0175 (0,75 m), FLX01150 (1,5 m), FLX013 (3 m), FLX016 (6 m), FLX0110 (10 m).
- DAP Audio cable for the demanding user with exceptional audio-qualities and connector made by Neutrik®. **Ordercode** FL71150 (1,5 m), FL713 (3 m), FL716 (6 m), FL7110 (10 m).
- DAP Audio cable for the demanding user with exceptional audio-qualities and connector made by Neutrik®. **Ordercode** FL7275 (0,75 m), FL72150 (1,5 m), FL723 (3 m), FL726 (6 m), FL7210 (10 m).
- DAP Audio 110 Ohm cable with digital signal transmission. **Ordercode** FL0975 (0,75 m), FL09150 (1,5 m), FL093 (3 m), FL096 (6 m), FL0910 (10 m), FL0915 (15 m), FL0920 (20 m).
- DAP Audio DMX adapter: 3-pin/5-pin. **Ordercode** FLA30.

Control Panel

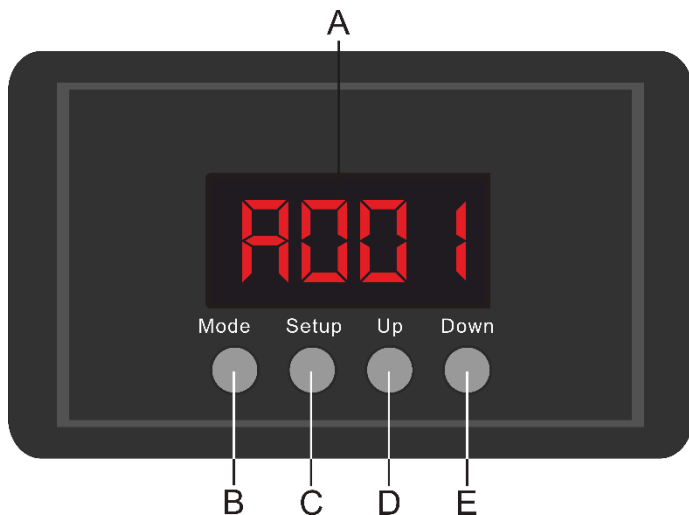

- A. LED Display
- B. Mode button
- C. Setup Button
- D. Up Button
- E. Down Button

Fig. 04

DMX Control Mode

The fixtures are individually addressed on a data-link and connected to the controller. The fixtures respond to the DMX signal from the controller. (When you select the DMX address and save it, the controller will display the saved DMX address the next time.)

DMX Addressing

The control panel on the front side of the base allows you to assign the DMX fixture address, which is the first channel from which the Light Bar will respond to the controller. Please note when you use the controller, the unit has up to **26** channels. When using multiple Light Bars, make sure you set the DMX addresses right. Therefore, the DMX address of the first Light Bar should be **1(d001)**; the DMX address of the second Light Bar should be **1+26=27 (d027)**; the DMX address of the third Light Bar should be **27+26=53 (d053)**, etc. Please, be sure that you do not have any overlapping channels in order to control each Light Bar correctly. If two or more Light Bars are addressed similarly, they will work similarly.

Controlling:

After having addressed all Light Bars, you may now start operating these via your lighting controller.

Note: After switching on, the Light bar will automatically detect whether DMX 512 data is received or not. The problem may be:

- The XLR cable from the controller is not connected with the input of the Light Bar.
- The controller is switched off or defective, the cable or connector is defective, or the signal wires are swapped in the input connector.

Note: It is necessary to insert a XLR termination plug (with 120 Ohm) in the last fixture in order to ensure proper transmission on the DMX data link.

Menu overview

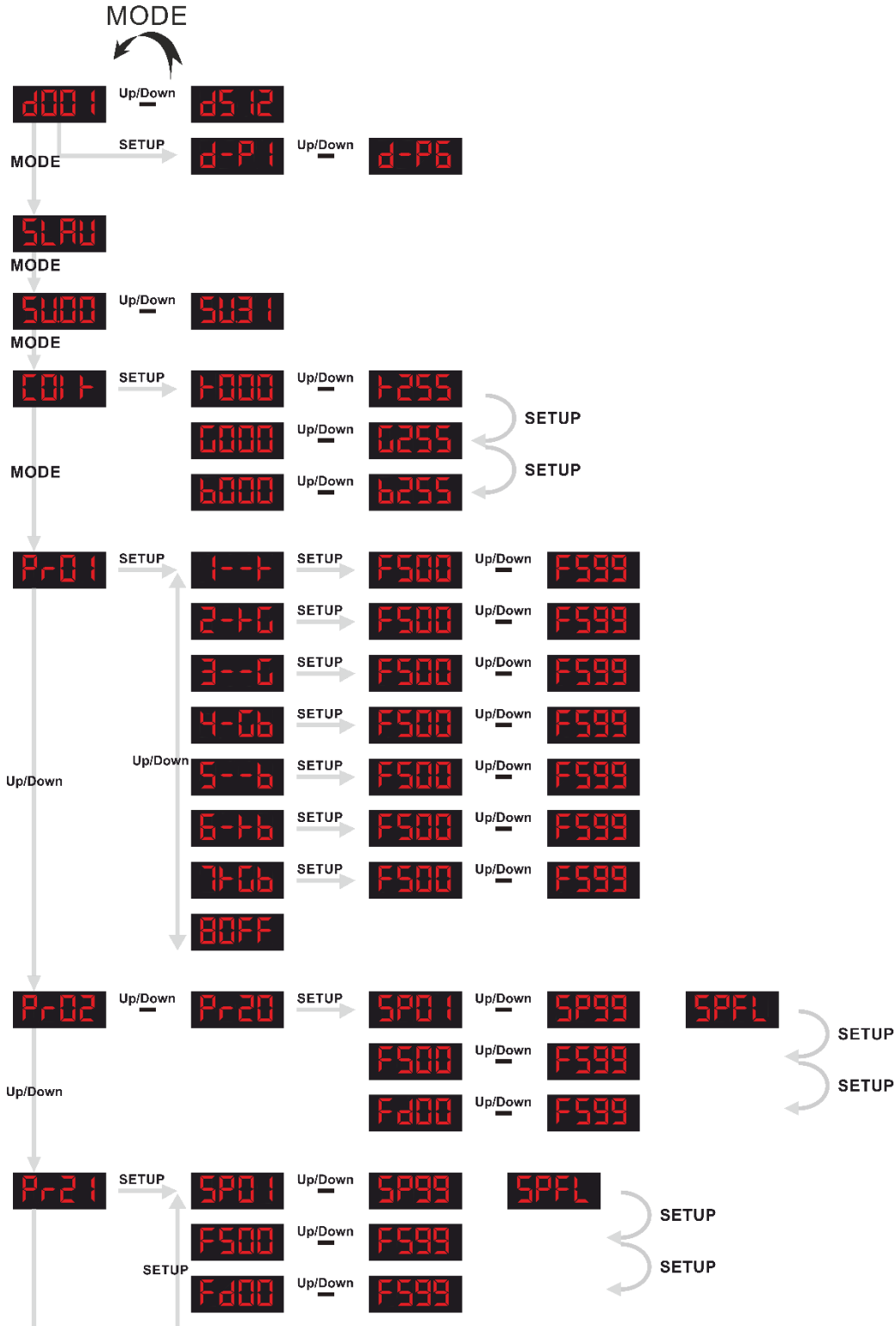

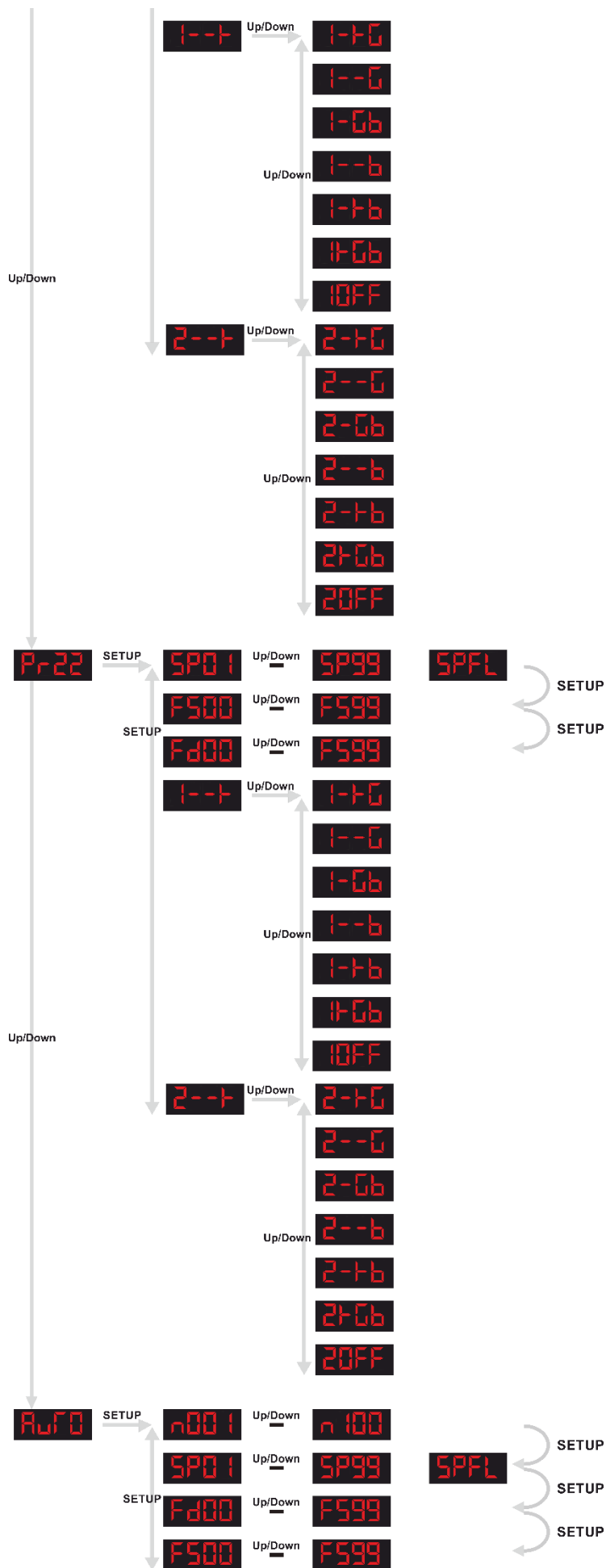

Main Menu Options

	DMX address
	Slave
	Sound controlled
	Color
	Built-in Programs
	Auto

The LED Light Bar 8 will only show its version number at start-up !









1. DMX Mode

With this menu you can set the DMX address.

01) Press the **MODE** button, until the display shows .

02) You can choose 512 different DMX addresses.

03) Use the **Up** and **Down** buttons to select the required address between   .

04) You can also press the **SETUP** button to set a different DMX Mode   .

 3 Channels

 4 Channels

 14 Channels

 26 Channels

 2 Channels

 7 Channels

2. Master / slave addressing

Master

01) The default setting for this device is master.

02) Only one fixture can be the master.

Note:

- Disconnect the fixture from the DMX controller before master/slave operating, otherwise data collisions may occur and the fixtures will not work properly!
- In master/slave mode, the master fixture can execute the built-in programs, all the slave fixtures will work the same.
- When operating the master/slave chain, you can identify the master fixture from the slave fixtures easily. The master doesn't have any cable plugged into the DMX input connector.

Slave control

This function allows you to control the slaves from the master's control panel in a master/slave operation.

01) Only 1 fixture can be the master, the others have to be Slaves. The Default setting for a device is Master. So on the first device you don't have to change anything.

On the slave devices you must press the **MODE** button until the display shows .

02) All slave devices must have address .

3. Sound control Mode

Press the **MODE** button on the device, until the display shows **SU00**. Turn on the music and the LED Light Bar will react to the beat of the music.



You can set the sensitivity from low-sensitivity to high-sensitivity between SU.00 - SU.31 with the **Up** and **Down** buttons.

4. Static Color Mode

With this menu you can set the static color.

- 01) Press the **MODE** button, until the display shows **COFF**.
- 02) With this menu you can set 3 Static colors of the LED Light Bar.

R000  **R255** Set the value of the red LEDs (000-255).

G000  **G255** Set the value of the green LEDs (000-255).

B000  **B255** Set the value of the blue LEDs (000-255).

- 03) You can use the **SETUP** button to scroll through the 3 color options.
- 04) Use the **Up / Down** buttons to select the values of each individual color from 000-255.
- 05) You can combine Red, Green and Blue to create an infinite range of colors.

5. Built-in Programs

- 01) Press the **MODE** button on the device, until the display shows **Pr01**.
- 02) With this menu you can set the Built-in Program Mode of the LED Light Bar. You can choose 22 built-in programs **Pr01**  **Pr22**, by using the **Up** and **Down** buttons.
- 03) Press **Setup** to enter the built-in programs Menu. You can choose 3 different sub menus:



See the next page to view the complete menu.

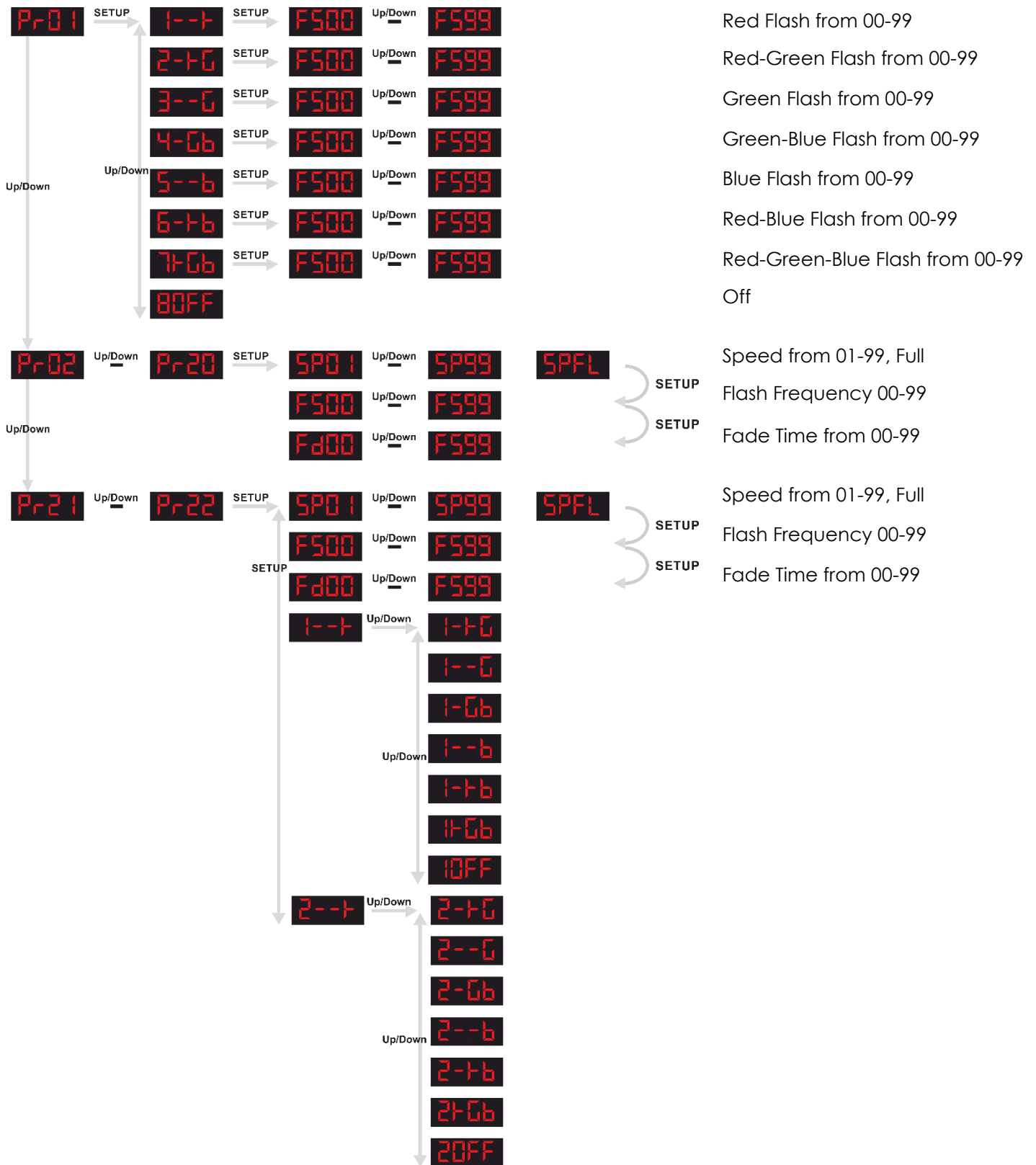

The specialty about menu 21 and 22 is, that you can combine both menus!!!!



Examples

Menu 20

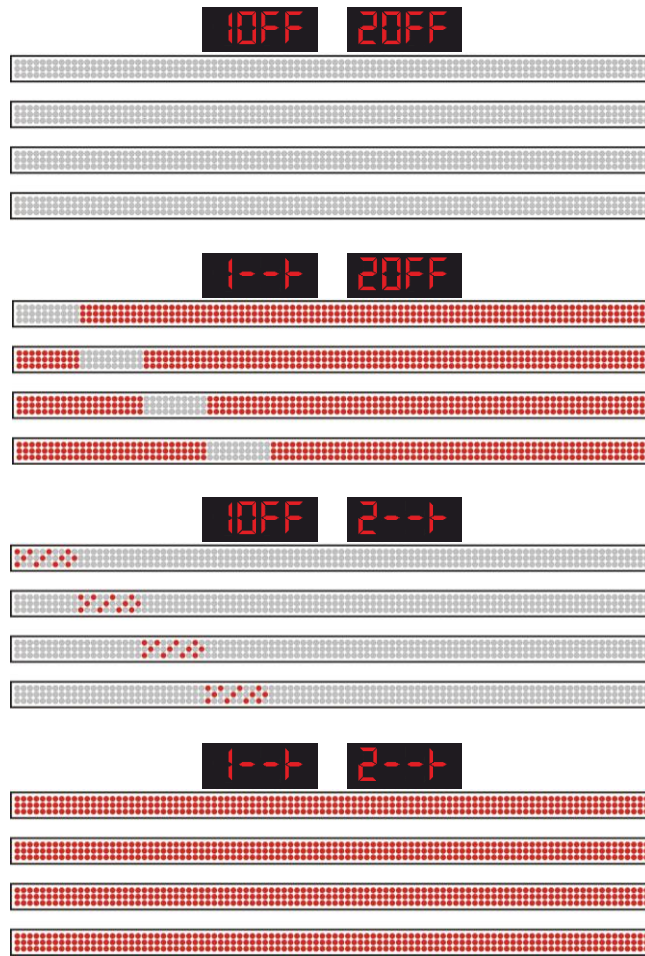

Menu 21



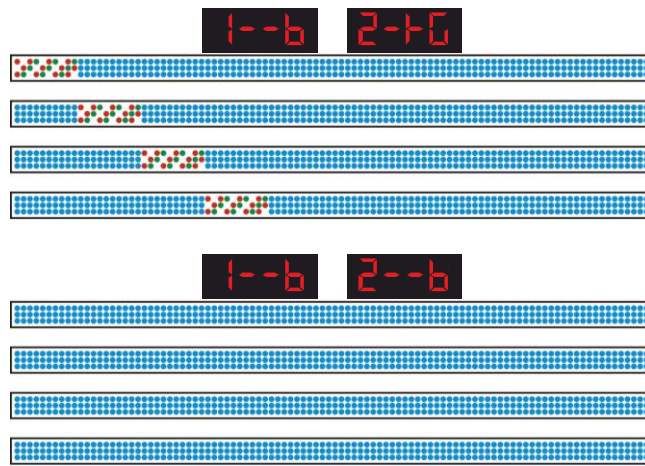

6. Auto Run Program

- 01) Press the **MODE** button on the device, until the display shows **AUTO**.
- 02) With this menu you can set the Auto Mode of the LED Light Bar.
- 03) Press **Setup** to enter the AUTO Menu. You can choose 4 different sub menus.

n00	Up/Down	n100	Number of Loops from 01-100
SP0	Up/Down	SP99 SPFL	Speed from 01-99 and FL
F500	Up/Down	F599	Flash Frequency from 00-99
F200	Up/Down	F299	Fade Time from 00-99

- 04) Use the **SETUP** button to scroll through the menu.

DMX Channels

3 DMX Channels (d-P1)

Channel 1 – Red

0-255 Gradual adjustment Red from 0 – 100%

Channel 2 – Green

0-255 Gradual adjustment Green from 0 – 100%

Channel 3 – Blue

0-255 Gradual adjustment Blue from 0 – 100%

4 DMX Channels (d-P2)

Channel 1 – Red (Dimmer must be open)

0-255 Gradual adjustment Red from 0 – 100%

Channel 2 – Green (Dimmer must be open)

0-255 Gradual adjustment Green from 0 – 100%

Channel 3 – Blue (Dimmer must be open)

0-255 Gradual adjustment Blue from 0 – 100%

Channel 4 – Master Dimmer

0-255 Dimmer, from closed to open (0-100%)

14 DMX Channels (d-P3)

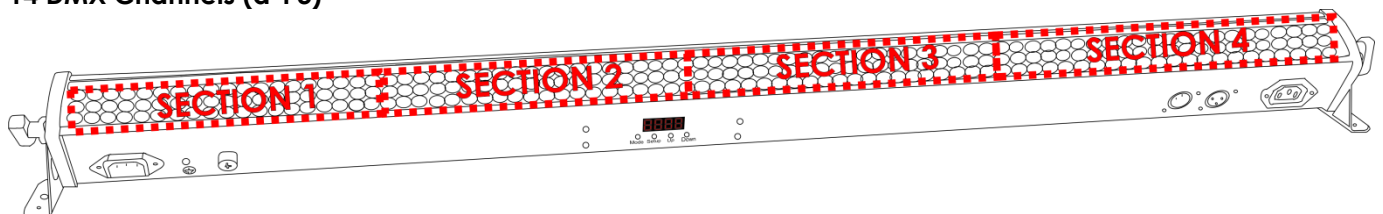

Channel 1 – Red Section 1

0-255 Gradual adjustment Red from 0 – 100%

Channel 2 – Green Section 1

0-255 Gradual adjustment Green from 0 – 100%

Channel 3 – Blue Section 1

0-255 Gradual adjustment Blue from 0 – 100%

Channel 4 – Red Section 2

0-255 Gradual adjustment Red from 0 – 100%

Channel 5 – Green Section 2

0-255 Gradual adjustment Green from 0 – 100%

Channel 6 – Blue Section 2

0-255 Gradual adjustment Blue from 0 – 100%

Channel 7 – Red Section 3

0-255 Gradual adjustment Red from 0 – 100%

Channel 8 – Green Section 3

0-255 Gradual adjustment Green from 0 – 100%

Channel 9 – Blue Section 3

0-255 Gradual adjustment Blue from 0 – 100%

Channel 10 – Red Section 4

0-255 Gradual adjustment Red from 0 – 100%

Channel 11 – Green Section 4

0-255 Gradual adjustment Green from 0 – 100%

Channel 12 – Blue Section 4

0-255 Gradual adjustment Blue from 0 – 100%

Channel 13 – Strobe (Dimmer must be open)

0-10 Shutter Open

11-255 Strobe effect from slow to fast

Channel 14 – Master Dimmer

0-255 Dimmer, from closed to open 0 – 100%

26 DMX Channels (d-P4)

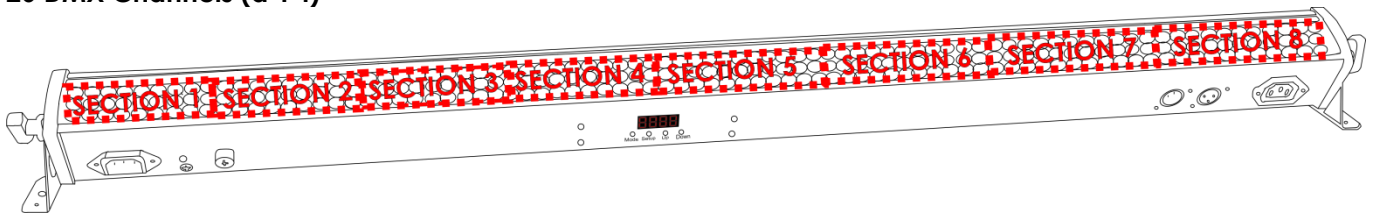

Channel 1 – Red Section 1

0-255 Gradual adjustment Red from 0 – 100%

Channel 2 – Green Section 1

0-255 Gradual adjustment Green from 0 – 100%

Channel 3 – Blue Section 1

0-255 Gradual adjustment Blue from 0 – 100%

Channel 4 – Red Section 2

0-255 Gradual adjustment Red from 0 – 100%

Channel 5 – Green Section 2

0-255 Gradual adjustment Green from 0 – 100%

Channel 6 – Blue Section 2

0-255 Gradual adjustment Blue from 0 – 100%

Channel 7 – Red Section 3

0-255 Gradual adjustment Red from 0 – 100%

Channel 8 – Green Section 3

0-255 Gradual adjustment Green from 0 – 100%

Channel 9 – Blue Section 3

0-255 Gradual adjustment Blue from 0 – 100%

Channel 10 – Red Section 4

0-255 Gradual adjustment Red from 0 – 100%

Channel 11 – Green Section 4

0-255 Gradual adjustment Green from 0 – 100%

Channel 12 – Blue Section 4

0-255 Gradual adjustment Blue from 0 – 100%

Channel 13 – Red Section 5

0-255 Gradual adjustment Red from 0 – 100%

Channel 14 – Green Section 5

0-255 Gradual adjustment Green from 0 – 100%

Channel 15 – Blue Section 5

0-255 Gradual adjustment Blue from 0 – 100%

Channel 16 – Red Section 6

0-255 Gradual adjustment Red from 0 – 100%

Channel 17 – Green Section 6

0-255 Gradual adjustment Green from 0 – 100%

Channel 18 – Blue Section 6

0-255 Gradual adjustment Blue from 0 – 100%

Channel 19 – Red Section 7

0-255 Gradual adjustment Red from 0 – 100%

Channel 20 – Green Section 7

0-255 Gradual adjustment Green from 0 – 100%

Channel 21 – Blue Section 7

0-255 Gradual adjustment Blue from 0 – 100%

Channel 22 – Red Section 8

0-255 Gradual adjustment Red from 0 – 100%

Channel 23 – Green Section 8

0-255 Gradual adjustment Green from 0 – 100%

Channel 24 – Blue Section 8

0-255 Gradual adjustment Blue from 0 – 100%

Channel 25 – Strobe (Dimmer must be open)

0-255 Strobe effect from slow to fast

Channel 26 – Master Dimmer

0-255 Dimmer, from closed to open 0 – 100%

2 DMX Channels (d-P5)**Channel 1 – Color**

0-7	No Function
8-15	Red
16-23	Yellow
24-31	Green
32-39	Cyan
40-47	Blue
48-55	Purple
56-63	White
64-71	Program 1
72-79	Program 2
80-87	Program 3
88-95	Program 4
96-103	Program 5
104-111	Program 6
112-119	Program 7
120-127	Program 8
128-135	Program 9
136-143	Program 10
144-151	Program 11
152-159	Program 12
160-167	Program 13
168-175	Program 14
176-183	Program 15
184-191	Program 16
192-199	Program 17
200-207	Program 18
208-215	Program 19
216-223	Program 20
224-231	Program 21
232-255	Sound Mode

Channel 2 – No Function (Channel 1 is set between 0-7 )

0-255	No function
-------	-------------

Channel 2 – Speed (Channel 1 must be set between 8-231 )

0-255	From slow to fast
-------	-------------------

Channel 2 – Sensitivity (Channel 1 must be set between 232-255 )

0-255	From low to high sensitivity
-------	------------------------------

7 DMX Channels (d-P6)

Channel 1 – Red

0-255 Gradual adjustment Red from 0 – 100%

Channel 2 – Green

0-255 Gradual adjustment Green from 0 – 100%

Channel 3 – Blue

0-255 Gradual adjustment Blue from 0 – 100%

Channel 4 – Color

0-7	No Function
8-15	Red
16-23	Yellow
24-31	Green
32-39	Cyan
40-47	Blue
48-55	Purple
56-63	White
64-71	Program 1
72-79	Program 2
80-87	Program 3
88-95	Program 4
96-103	Program 5
104-111	Program 6
112-119	Program 7
120-127	Program 8
128-135	Program 9
136-143	Program 10
144-151	Program 11
152-159	Program 12
160-167	Program 13
168-175	Program 14
176-183	Program 15
184-191	Program 16
192-199	Program 17
200-207	Program 18
208-215	Program 19
216-223	Program 20
224-231	Program 21
232-255	Sound Mode

Channel 5 – No Function (Channel 4 is set between 0-7)

0-255 No function

Channel 5 – Speed (Channel 4 must be set between 8-231)

0-255 From slow to fast

Channel 5 – Sensitivity (Channel 4 must be set between 232-255)

0-255 From low to high sensitivity

Channel 6 – No Function (Channel 4 is set between 0-7 or 232-255)

0-255 No function

Channel 6 – Strobe (Channel 4 must be set between 8-231)

0-255 Strobe effect from slow to fast

Channel 7 – Master Dimmer

0-255 Dimmer, from closed to open (0-100%)

Maintenance

The operator has to make sure that safety-relating and machine-technical installations are to be inspected by an expert after every year in the course of an acceptance test.

The operator has to make sure that safety-relating and machine-technical installations are to be inspected by a skilled person once a year.

The following points have to be considered during the inspection:

- 01) All screws used for installing the device or parts of the device have to be tightly connected and must not be corroded.
- 02) There may not be any deformations on housings, fixations and installation spots.
- 03) Mechanically moving parts like axles, eyes and others may not show any traces of wearing.
- 04) The electric power supply cables must not show any damages or material fatigue.

The Showtec LED Light Bar 8 requires almost no maintenance. However, you should keep the unit clean. Otherwise, the fixture's light-output will be significantly reduced. Disconnect the mains power supply and then wipe the cover with a damp cloth. Wipe the front glass panel clean with glass cleaner and a soft cloth. Do not use alcohol or solvents. The front glass panel will require weekly cleaning, as smoke-fluid tends to build up residues, reducing the light-output very quickly. Do not immerse in liquid.

The cooling-fans and the internal lenses should be cleaned monthly with a soft brush.

Please clean internal components once a year with a light brush and vacuum cleaner.

Keep connections clean. Disconnect electric power, and then wipe the DMX and audio connections with a damp cloth. Make sure connections are thoroughly dry before linking equipment or supplying electric power.

Replacing a Fuse

Power surges, short-circuit or inappropriate electrical power supply may cause a fuse to burn out. If the fuse burns out, the product will not function whatsoever. If this happens, follow the directions below:

- 01) Unplug the unit from electric power source.
- 02) Insert a flat-headed screwdriver into a slot in the fuse cover. Turn the screwdriver to the left, at the same time gently push a bit (Turn and Push). The fuse will come out.
- 03) Remove the used fuse. If brown or unclear, it is burned out.
- 04) Insert the replacement fuse into the holder where the old fuse was. Reinsert the fuse cover. Be sure to use a fuse of the same type and specification. See the product specification label for details.

Troubleshooting

No Light

This troubleshooting guide is meant to help solve simple problems.

If a problem occurs, follow the steps below in sequence until a solution is found. Once the unit operates properly, do not carry out the following steps.

If the light effect does not operate properly, refer servicing to a technician.

Response: Suspect three potential problem areas as the power supply, the LEDs, the fuse.

- 01) Power supply. Check that the unit is plugged into an appropriate power supply.
- 02) The LEDs. Return the LED Light Bar 8 to your Showtec dealer.
- 03) The fuse. Replace the fuse. See page 24 for replacing the fuse.
- 04) If all of the above appears to be in order, switch the unit on again.
- 05) If you are unable to determine the cause of the problem, do not open the LED Light Bar 8, as this may damage the unit and the warranty will become void.
- 06) Return the device to your Showtec dealer.

No Response to DMX

Response: Suspect the DMX cable or connectors, a controller malfunction, a light effect DMX card malfunction.

- 01) Check the DMX setting. Make sure that DMX addresses are correct.
- 02) Check the DMX cable: Unplug the unit; change the DMX cable; then reconnect to electrical power. Try your DMX control again.
- 03) Determine whether the controller or light effect is to blame. Does the controller operate properly with other DMX products? If not, take the controller in for repair. If it does, take the DMX cable and the light effect to a qualified technician.

Problem	Probable cause(s)	Solution
One or more fixtures do not function at all	No power to the fixture	<ul style="list-style-type: none"> • Check if power is switched on and cables are plugged in
	Primary fuse blown	<ul style="list-style-type: none"> • Replace fuse
Fixtures reset correctly, but all respond erratically or not at all to the controller	The controller is not connected	<ul style="list-style-type: none"> • Connect controller
	3-pin DMX OUT of the controller does not match DMX IN of the first fixture on the link (i.e. signal is reversed)	<ul style="list-style-type: none"> • Install a phase reversing cable between the controller and the first fixture on the link
Fixtures reset correctly, but some respond erratically or not at all to the controller	Poor data quality	<ul style="list-style-type: none"> • Check data quality. If much lower than 100 percent, the problem may be a bad data link connection, poor quality or broken cables, missing termination plug, or a defective fixture disturbing the link
	Bad data link connection	<ul style="list-style-type: none"> • Inspect connections and cables. Correct poor connections. Repair or replace damaged cables
	Data link not terminated with 120 Ohm termination plug	<ul style="list-style-type: none"> • Insert termination plug in the DMX OUT connector of the last fixture on the link
	Incorrect addressing of the fixtures	<ul style="list-style-type: none"> • Check address settings
	One of the fixtures is defective and disturbs data transmission on the link	<ul style="list-style-type: none"> • Bypass one fixture at a time until normal operation is restored: unplug both connectors and connect them directly together • Have the defective fixture serviced by a qualified technician
	3-pin DMX OUT on the fixtures does not match (pins 2 and 3 reversed)	<ul style="list-style-type: none"> • Install a phase-reversing cable between the fixtures or swap pin 2 and 3 in the fixture that behaves erratically
No light or LEDs cut out intermittently	Fixture is too hot	<ul style="list-style-type: none"> • Allow the fixture to cool down • Clean the fans • Make sure the cooling fans are not blocked • Turn up the air conditioning
	LEDs are damaged	<ul style="list-style-type: none"> • Disconnect the fixture and return it to your dealer
	The power supply settings do not match local AC voltage and frequency	<ul style="list-style-type: none"> • Disconnect fixture. Check settings and correct if necessary

Product Specifications

Model:	Showtec LED Light Bar 8
Input Voltage:	100-240 VAC
Drive Current:	20 mA
Power consumption @FO	23 Watt
DMX linking:	30pcs
Fuse:	T1A / 250V
Dimensions:	1070 x 65 x 88 mm (LxWxH)
Weight:	1,58 kg
Operating and Programming:	
Signal pin OUT:	Pin 1 (earth), pin 2 (-), pin 3 (+)
DMX Mode:	2, 3, 5 and 24 DMX channel operation
Signal input:	3-pin XLR male
Signal output:	3-pin XLR female
Electro-mechanical effects:	
Light source:	240 RGB high intensity 10mm LEDs (Red 96, Green 72, Blue 72)
Output:	800Lumen
Lux @2m:	613,3
Beam Angle:	30 °
Refresh rate:	11,6 KHz
Max. Distance:	15m
Sections:	8
Dimmer:	0-100%
Strobe:	0-17Hz
Color Range:	RGB
Housing:	Black aluminum material
DMX-control:	DMX512 via standard DMX-controller
Onboard:	Red LED Digital display
Control:	Built-in programs mode, Auto running mode, DMX mode, slave mode, sound-activated mode
Connections:	XLR Data in/out (XLR 3-pin), IEC Power In and IEC power Out (Max. 10A)
Max. ambient temperature t_a :	40°C
Max. housing temperature t_b :	80°C
Minimum distance:	
Minimum distance from flammable surfaces:	0,5 m
Minimum distance to lighted object:	1 m

Design and product specifications are subject to change without prior notice



Website: www.Showtec.info

Email: service@highlite.com

Dimensions

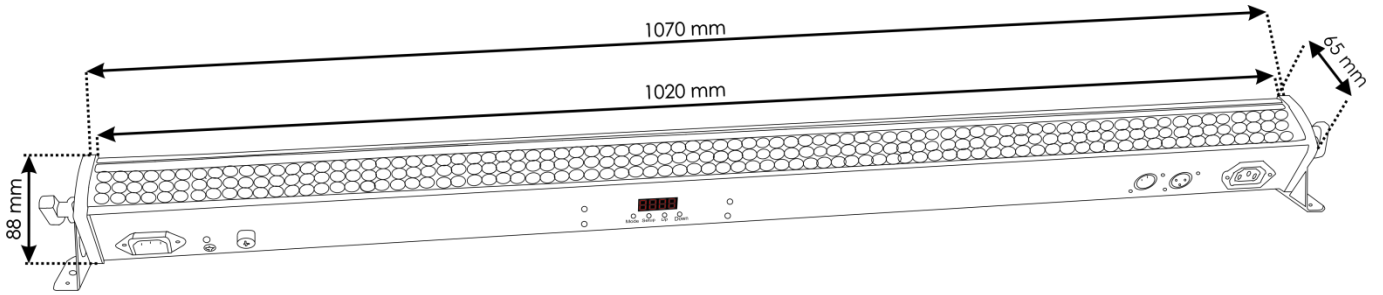

Bracket dimensions

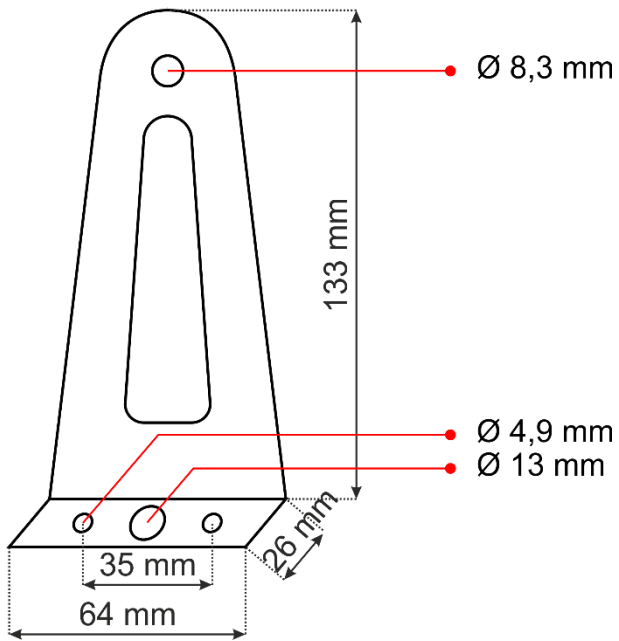



©2020 Showtec